

# HELICOPTER RESCUE TECHNIQUES

*Civilian Public Safety and Military Helicopter Rescue Operations*

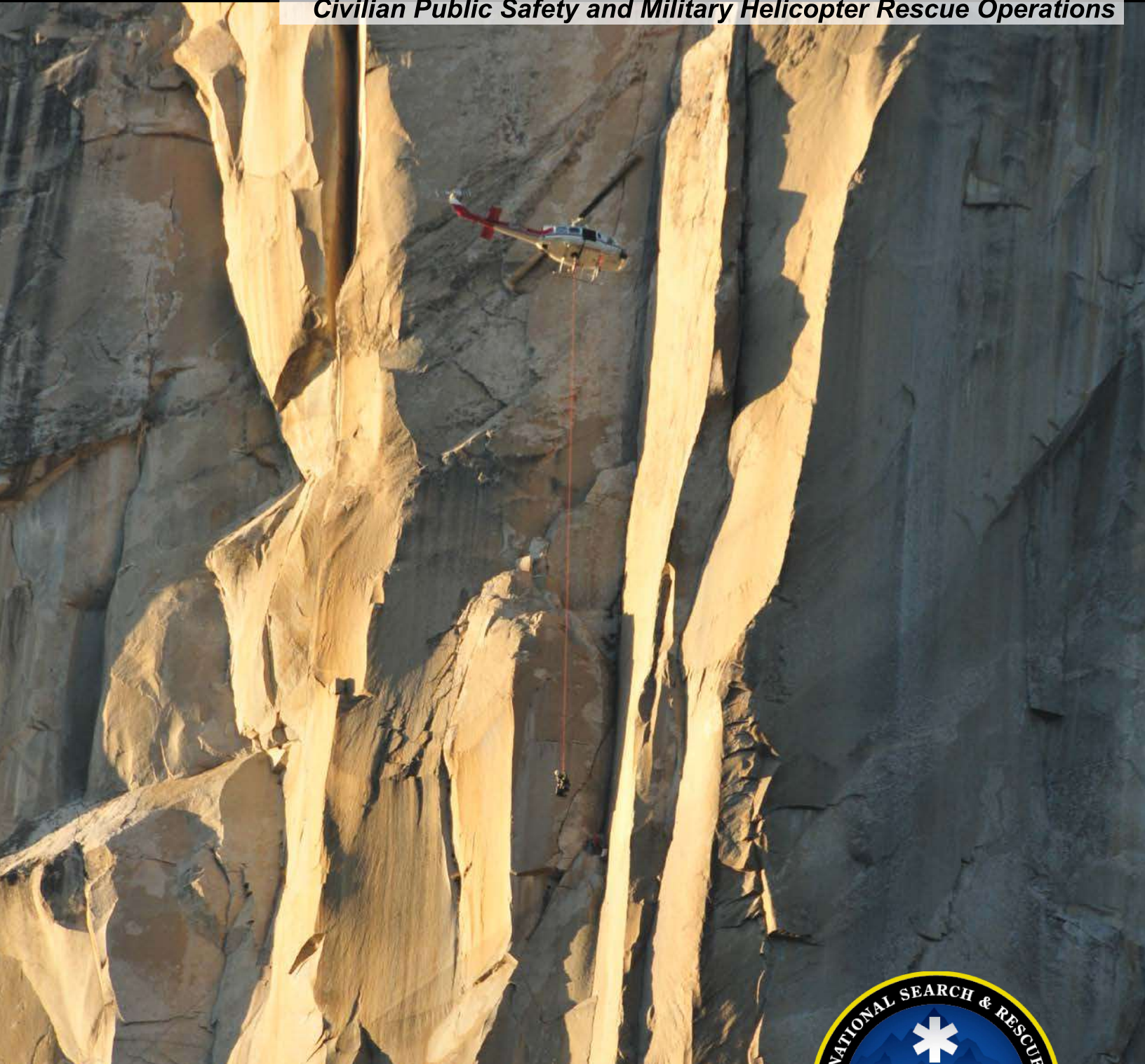

**National SAR Academy Training Manual**



This page intentionally blank

# Helicopter Rescue Techniques

Civilian Public Safety and Military Helicopter Rescue Operations

First edition

October 2013

This training manual has been prepared by the United States Department of the Interior, National Park Service for the National SAR Academy (NSARA).

As a publication of the federal government the text within this manual is not copyrighted under the copyright laws of the United States, however this manual does contain copyrighted images and illustrations. Such material is protected by United States Copyright Law and may not be reproduced without the express permission of the owner.

Written by Ken Phillips, Branch Chief of Search and Rescue, National Park Service (NPS).

The author is extremely grateful for the technical assistance of numerous individuals within the helicopter rescue community for their personal insight and suggestions. This includes; Cedric Smith, Engineer with CMC Rescue and helicopter SAR technician with Santa Barbara County SAR; Jim Frank, founder of CMC Rescue for his skill as an editor; Casey Ping, Program Manager with Travis County Starflight; Greg Sanderson, Firefighter/Paramedic and Helitac Standardization Coordinator with Los Angeles City Fire Department Air Operations; Diana Byrne for her editing. Additional contributions were provided by U.S. Park Police Aviation Unit, Yosemite SAR (YOSAR), Dean Ross, NPS Deputy Chief of Emergency Services, John Evans, NPS Park Ranger, Michael Peitz, Interagency Aviation Officer (USMC ret), Will Smith MD, and the staff of the USMC Mountain Warfare Training Center, California.

All images credited as noted. All copyrighted images reprinted with permission.

The use of commercial products and trade names is for illustrative and educational purposes only and does not constitute an official endorsement by the National Park Service.

**Cover photo:** Helicopter short-haul rescue of an Austrian climber on the 3'000 foot El Capitan Nose Route at Yosemite National Park (CA). During the third day of his ascent on September 26, 2011, the climber, who was 2,000 feet above the floor of Yosemite Valley, clipped an etrier, a short ladder of sewn webbing, to a metal nut wedged in a rock crack. As he stood with his weight on the etrier, the nut pulled loose and he sustained a fall, being caught by his belay safety line. During the fall, the etrier became wrapped around his thumb, amputating the digit. Yosemite Search and Rescue (YOSAR) personnel Dave Pope and Jeff Webb were inserted to the scene, in order to extract the injured climber beneath Helicopter 551 (Bell 205A-1) helicopter being piloted by Richard Shatto with assistance from helicopter crew chief Eric Small. NPS Photo by Dov Bock.

## WARNING

Helicopter rescue involves unique hazards, which can be fatal. This manual contains information on specialized rescue techniques, and is intended for use as a part of a training course involving closely supervised field training with qualified instructors. A person cannot become proficient in helicopter rescue by only reading this manual. Every rescue situation is unique, requiring size-up and decision-making skills gained through personal experience.

## Table of Contents

Introduction.....	6
When to Use a Helicopter .....	6
Weather and Nighttime Limitations .....	10
Night Rescue Operations by Helicopter .....	10
Preplanning and Mission Planning .....	12
Risk Management Process.....	15
U.S. Coast Guard and Operational Risk Management .....	16
GAR Risk Assessment Model.....	17
Public Aircraft Regulations- FAA .....	19
Public Aircraft.....	19
Rotorcraft External Load Operations- Public Aircraft .....	19
Mission Management .....	20
Flight Following .....	20
Crew Resource Management .....	20
Communications.....	21
Five Communication Responsibilities for All Personnel: .....	21
Hand Signals.....	22
Using Direct Statements .....	22
Briefing Personnel.....	24
Multi-Tasking.....	24
Landing Zones.....	25
Rotor Wash.....	26
Hot Loading.....	27
Aircraft Weight and Balance .....	28
Load Calculation .....	28
Helicopter Rescue Crew Configuration .....	30
Helicopter Flight Characteristics and Limitations.....	31
Helicopter Aerodynamics .....	31
Ground Effect.....	32
Autorotation.....	32
Translational Lift.....	33
Density Altitude .....	33
Hover Ceiling .....	33
Center of Gravity.....	33
Helicopter Landings.....	33
Slope Landings .....	34
One-Skid Landings .....	34
Toe-In Landings .....	34
Hover Landings.....	35
Power-On Landing.....	35
Basic Helicopter Safety .....	35
Preflight Briefing.....	35
Safety During Helicopter Operations.....	35
Personnel Protective Equipment .....	36
Personal Preparedness .....	39
In-Flight Emergency: Survival Plan Checklist.....	39

Emergency Water Ditching Survival Training.....	39
Patient Care and Transport Considerations .....	40
Helicopter Rescue Techniques.....	42
Helicopter Hoist Rescue .....	42
Hoist Cable Management.....	44
Hoist Cable Construction.....	45
Hoist Cable and Rescue Hook Assembly.....	46
Possible Cable Damage .....	47
Static Discharge .....	48
Line Entanglement .....	49
Litter Transfer in Exposed Terrain .....	54
Helicopter Rappel .....	54
Helicopter Short-haul .....	56
Short-haul Operational Hazards.....	60
Litter Transfer in Exposed Terrain (similar to hoist procedures).....	61
Short-haul Emergency Procedures .....	62
Rescuer Head-to-toe Safety Checklist (HEC Techniques).....	64
Helicopter Short-Haul Checklist (Pre-Mission) .....	64
Helicopter Rescue Appliances.....	65
Helicopter Rescue Bags .....	65
Collapsible Rescue Basket .....	66
Rescue Net (Billy Pugh Net) .....	66
Medevac Litter .....	68
Rescue Seat or Forest Penetrator (Jungle Penetrator).....	68
Tag Line/Trail Line .....	70
Additional Personnel Lifting Devices.....	70
Rescue Strop.....	70
Quick Strop.....	71
Rescue Evacuation Triangle (Petzl Pitagor).....	72
Screamer Suit.....	72
Hoisting Vest .....	73
Post Incident Considerations.....	73
Helicopter Rescue Training Considerations .....	75
Summary .....	75
Bibliography.....	77
References .....	81
Glossary .....	82
APPENDICES .....	92
Appendix A- Checklist For Precision In Emergency Response Safety .....	92
Appendix B- Communications.....	94
Appendix C- Helicopter Hoist Rescue Checklists.....	96
California Highway Patrol.....	98
Appendix D- Airspace .....	103
Appendix E- Military Rescue Helicopters .....	106
Appendix F- U.S. Air Force Helicopter Landing Zone (HLZ) Requirements.....	110
Appendix G- JFIRE Manual- Helicopter Landing Zone (HLZ) Brief.....	112

## Introduction

Helicopters provide an outstanding rescue tool, but they have specific operating limitations. Recognize that the consequences of a poorly managed helicopter rescue can be swift and fatal. Rescuers need to understand these limits and have the professional discipline not to exceed them during an emergency. As accident investigators repeatedly conclude, “self-imposed psychological pressure” causes us to make poor decisions when adrenaline clouds our judgment. Poor decision-making is preventable yet, tragically, it is a factor in the vast majority of helicopter rescue accidents.

You cannot disregard the fact that a helicopter is a machine. You might expect it to provide dependable service, but helicopters do break down, disrupting operational plans or leaving rescuers stranded. Always be prepared with backup plans and require field rescuers to be prepared. A helicopter is one additional operational tool for rescue, not a panacea to be applied in every rescue situation.

Before launching a helicopter for a rescue or requesting the assistance of an outside agency with aviation assets, make sure your decisions are not being driven by the excitement of the moment. Rescue crews often show poor judgment by “pressing on” in degraded operating conditions for a non-life-threatening injury that could easily handle a delay. The option of delaying the mission in favor of safer operating conditions is repeatedly overlooked and requires considerable discipline on the part of a rescue team. Remarkably, accidents with the same root cause occur over and over. As rescuers, we must learn from these mistakes and break this dangerous pattern of repetition.

## When to Use a Helicopter

Rescue helicopters may be utilized to efficiently extricate a subject from an otherwise inaccessible accident scene. Situations that involve remote locations with critical injuries are very appropriate for a helicopter-based rescue (Figure 1). An injured subject can then be transferred to a helicopter emergency medical services (HEMS) aircraft or ground based ambulance, as appropriate, with the proper continuity of care to match the situation.



**Figure 1- Helicopter Rescue.** A twin-engine AugustaWestland (AW) Da Vinci Helicopter, developed for the high altitude requirements of Swiss rescue operator REGA, responds in the mountains. Photo copyright Swiss Air-Rescue (REGA).

When multiple transportation options are available, rescuers should determine which technique offers the least risk and greatest gain both for rescuers and the rescue subject. Evaluate the totality of the circumstances surrounding the incident, including the duration and difficulty of a conventional evacuation, rescuer and patient safety, the severity of the patient's injury, current and projected environmental hazards, personnel and aircraft availability, and transport time to a definitive care facility.

The following questions can assist in the decision to use a helicopter for rescue:

- Are conditions adequate for communication with all involved rescue personnel, or do communications barriers exist?
- Is a safe landing site available within a reasonable distance of the accident site?
- Does the urgency of the subject's condition require getting someone to the accident site as quickly as possible?
- Is the risk associated with traversing terrain to the accident scene greater than the risk of using specialized helicopter rappel, short-haul, or hoisting techniques?
- Are all helicopter crewmembers proficient with the helicopter rescue technique being considered?
- Do extreme environmental factors prevent the use of a helicopter?
- Would the immediate insertion of advanced life support (ALS) care to the scene convert an urgent medical case to a lower priority ground evacuation?
  - *Insertion of a trained EMS provider, who conducts a proper assessment, may permit appropriately downgrading the rescue plan to a ground ambulance transport of the patient. The primary task of the rescue helicopter is locating and assessing the patient with transport to definitive care being conducted when justified.*

### **Mission Decisions**

1. **Assess the situation:** Weigh the relative level of urgency, the condition of the rescue subject (or subjects), and stability of the incident.
2. **Determine the alternatives:** Review the various rescue options, including the level of complexity and the risk involved. Greater complexity and risk add significantly to the potential for mission failure.
3. **Select an alternative:** The choice of an appropriate rescue plan should be based on the safety of rescuers rather than the safety of the subject.
4. **Execute the plan:** Initiate the rescue response according to established procedures and reevaluate your ongoing actions. Avoid the "press on regardless" mentality. If the plan is not working, change your operational response.

### **MILITARY SUPPORT TO CIVIL SEARCH AND RESCUE**

Search and rescue of the civilian population in an emergency can be carried out by DoD as a humanitarian and legal obligation under the overall arrangements and principles described in the National Search and Rescue Plan (NSP). It is United States policy, under the NSP, to use all available resources to carry out national civil SAR responsibilities. These include Federal civil and military resources, state and local

resources, private and volunteer resources, and resources available through international cooperative efforts, as appropriate.

The Air Force Rescue Coordination Center (AFRCC), located at Tyndall Air Force Base, FL, serves as the single agency responsible for coordinating on-land federal SAR activities in the 48 contiguous United States while also providing SAR assistance to Mexico and Canada.



Additionally, the AFRCC will not launch a rescue helicopter for a known civilian fatality recovery, unless the ground recovery effort would place a rescue team in potential jeopardy. Regardless, fatality recovery requests will be evaluated on a case-by-case basis for approval by the commanding officer of the responding SAR unit.

### **AFRCC MISSION GO/NO GO CRITERIA.**

The mission coordinator determines that a valid distress or perceived distress situation exists and no legal restrictions apply (Posse Comitatus, Stafford Act, etc.) Distress is the reasonable certainty that an aircraft (or other craft) or persons is threatened by grave and imminent danger and requires immediate assistance. The mission go/no-go criteria are a threat to **life, limb, eyesight, or undue suffering**. (AFRCC OI 10-406).

A request for a military helicopter rescue asset may require extended response time for required command approvals, flight crew recall, mission planning, and aircraft preparation. This can be well mitigated through advance planning. Initiate personal contacts at the military unit level, develop a formal written memorandum of understanding (MOU) between the requesting agency and the unit command, arrange for familiarity flights within the response area, and conduct training, which develop communications and procedural familiarity.

### **CASEVAC and MEDEVAC**

A military medical evacuation (MEDEVAC) is defined as the timely, efficient movement and enroute care by medical personnel of the wounded, injured, and ill persons, from the battlefield and other locations to treatment facilities. A Casualty Evacuation (CASEVAC) is the movement of casualties to initial treatment facilities in the combat zone, without enroute care by medical personnel. The term MEDEVAC is



**Figure 2- Medevac Helicopter.** A well-marked UH-72A Lakota assigned to 121st Medical Company. U.S. Army photo, Staff Sgt. Jon Soucy.



routinely used interchangeably to refer to both medical evacuations and casualty evacuations. MEDEVAC aircraft, which have medical care providers on board, are mandated by the Geneva Convention to be unarmed and well marked (Figure 2).

The military utilizes a “9 Line MEDEVAC Format” for requesting a helicopter evacuation on the battlefield. The format, with adaptation, can be employed during peacetime SAR operations as well. The initial five lines are most important and adequate for launch when calling in a MEDEVAC, the additional four lines can be relayed when aircraft are in the air.

<b>9 Line MEDEVAC Request Format</b>	
<b>Line 1</b>	Location of the pick-up site
<b>Line 2</b>	Radio frequency, call sign, and suffix
<b>Line 3</b>	Number of patients by precedence: A - Urgent B - Urgent Surgical C - Priority D - Routine E - Convenience
<b>Line 4</b>	Special equipment required: A - None B - Hoist C - Extraction equipment D - Ventilator
<b>Line 5</b>	Number of patients: A - Litter B - Ambulatory
<b>Line 6</b>	Security at pick-up site: N - No enemy troops in area P - Possible enemy troops in area (approach with caution) E - Enemy troops in area (approach with caution) X - Enemy troops in area (armed escort required) <b>* In peacetime - number and types of wounds, injuries, and illnesses</b>
<b>Line 7</b>	Method of marking pick-up site: A - Panels B - Pyrotechnic signal C - Smoke signal D - None E - Other
<b>Line 8</b>	Patient nationality and status: A - US Military B - US Civilian C - Non-US Military D - Non-US Civilian E – EPW (Enemy Prisoner of War)
<b>Line 9</b>	NBC Contamination: N - Nuclear B - Biological C - Chemical <b>* In peacetime - terrain description of pick-up site</b>

### **M.I.S.T. Report**

The M.I.S.T. Report can be incorporated into the 9 Line MEDEVAC report and traditionally is provided following the 9 Line format.

- M-** Mechanism of injury (IED, gunshot wound, MVA, etc.)
- I-** Type of Injury (found and or suspected)
- S-** Signs (pulse rate, blood pressure, respiratory rate)
- T-** Treatment given (ketamine, tourniquet, etc.)
- A/C-** Adult/Child (include age if known)

## **Weather and Nighttime Limitations**

Daytime flight operations for most aircraft are limited by visual flight rules (VFR) basic weather minimums include;

- One mile (1.6 km) of forward visibility
- 500 ft. (152 m) of clearance below a cloud ceiling
- 1000 ft. (300 m) above clouds
- 2000 ft. (610 m) horizontal clearance from clouds

Additionally, an exception applies to helicopters in “uncontrolled” airspace (Class G) below 1,200 ft. (366 meters) above ground level (AGL); in these areas, helicopters “may be operated clear of clouds if operated at a speed that allows the pilot adequate opportunity to see any air traffic or obstruction in time to avoid a collision” (FAR Part 91.155 b.1). A helicopter being operating in Class G airspace under FAR PART 135.205 (commercial on demand operations including HEMS) must have 1/2 mile of visibility during the day and one mile of visibility at night. Finally, check with the supporting helicopter asset for the final word on whether they launch for a mission.

U.S. federal land management agencies (U.S. Forest Service and Department of Interior) adhere to the following visibility and wind restrictions for “special use” missions (e.g., mountainous flying, unimproved helispot, or less than 500 ft. [152 m] AGL) involving light helicopters:

- Maximum sustained winds of 35 mph (30 knots)
- Wind gust spread (range from minimum to maximum) of 17 mph (15 knots)
- One-half mile (0.8 km) forward visibility.

## **Helicopter Night Rescue Operations**

Conducting a night rescue by helicopter in a remote setting dramatically increases operational risk. A study of HEMS accidents found that those air crashes occurring in darkness or bad weather increased the likelihood of a fatal outcome by 95%!<sup>1</sup> It is important to carefully review the option of stabilizing the subject at the scene and initiating the rescue at daybreak. VFR night flight minimum clearances (the visual distance minimums required for night-time flights) are three statute miles (4.8km) forward visibility and a minimum of 500 ft. (152 m) clearance beneath clouds (FAR Part

---

<sup>1</sup> Baker, Susan, et al. EMS Helicopter Crashes: What Influences Fatal Outcomes?

91.155). Furthermore, the FAA permits a helicopter to be operated clear of clouds “at a speed that allows the pilot adequate opportunity to see any air traffic or obstruction in time to avoid a collision.” (FAR 91.155(b)(1)).

The limitations of the human eye become more pronounced at night. The central portion of the retina, which is known as the fovea, is responsible for the sharpest visual acuity, hence “central vision” as opposed to “peripheral vision”. However, this portion of the eye lacks the presence of rod receptor cells, which have a higher sensitivity



**Figure 3- Night Vision Goggles.** Suspended from the front of a flight crewmember’s helmet. Image courtesy Travis County STAR Flight, Texas.

to light and aid in night vision, in contrast to cones, which are the other type of receptor cells in the eye. The foveola, or center of the fovea, lacking rods cannot function in diminished illumination thereby creating a central blind spot in the central 1 degree of the visual field. To overcome this limitation at night an individual should scan or look approximately 15-20 degrees to one side, thereby placing the object of interest on that part of the retina that possesses the highest density of rods.<sup>2</sup>

Night vision goggles (NVG) increase the aircrew’s situational awareness, ability to safely navigate, and dramatically decrease the associated risk (Figure 3). In comparison to daylight operations, they do have operational limitations, including reducing a user’s depth perception, which is an important factor during external work such as hoist operations. While operating NVG’s it is difficult to identify suspended wires, which are also difficult to see day or night. The goggles themselves have a narrow 40° field of view (smaller than the normal human binocular visual field of 120° [vertical] by 200° [horizontal])<sup>3</sup>, however since they are suspended over an inch from the eye they do not restrict the user from looking below the goggles or peripherally to the side in order to perform an unaided task.

Night vision goggles function by capturing all available existing ambient light, such as starlight or moonlight, which is comprised of photons and converting the photons into electrons with a photocathode tube. The electrons are then amplified and increased to a greater number through an electrical and chemical process. Against a phosphorus screen the amplified electrons are changed into visible light that can be seen as a green hued image in the eyepiece. NVG’s use a green colored screen (Figure 4), because the human eye is most sensitive to the wavelength spectrum associated with green light. Depending upon the detectability of a missing search subject, a SAR operator may consider delaying a search mission till darkness, based upon NVG’s

<sup>2</sup> American Optometric Association (AOA). The Eye and Night Vision.

<sup>3</sup> United Nations Logistics Base. Night Vision Goggles Limitations, page 2.

being able to detect any light source. A lighted cell phone can easily be seen by NVG from 1.2 miles (2km) on a dark night.

Night vision devices were initially developed in Germany during WWII and were in common use during the Vietnam War.<sup>4</sup> Initial night vision equipment (early 1960's) used Generation I (1,000X) image intensifier tube (IIT) technology, which is still being used in many popular consumer night vision devices. The first true night vision goggles were produced in the early 1980s using Generation II (20,000X) image intensifier tube technology. A drawback of the Generation II



**Figure 4- Night vision image.** HH-60 Pave Hawk from the 33rd Rescue Squadron takes off from Kadena Air Base, Japan. U.S. Air Force photo by Staff Sgt. Lakisha A. Croley

tube was that a bright light directed at it caused the tube to shut down as a self-protecting feature. Generation III (30,000-50,000X) technology can be adversely affected by bright lights in the field of view, which may result in the image being obscured by an effect known as halo. Current NVG's provide a user with 20/25 visual acuity.<sup>5</sup> Aircraft interiors must be appropriately configured with night-vision compatible lighting and displays to permit NVG operations. Ground personnel, when working with aircrews operating on NVG's should observe conscious "light discipline". Finally, recurrent training with NVG's is essential in order for aircrews to maintain operational proficiency.

## Preplanning and Mission Planning

For a helicopter rescue operation to succeed, sufficient preplanning must be done well in advance of the initial notification. Rescue teams should develop an in-depth knowledge of and working rapport with outside aviation resources through meetings and advance training. As part of the pre-plan, consider preparing an aerial hazard map for the local response area, one that identifies wires, power lines, and military operations areas (MOA), in addition to established helispots and staging areas with known coordinates. An aerial (aviation) hazards map of the local response area and posted at a command post or other operational location, provides an excellent mission-planning tool (Figure 5).

<sup>4</sup> Globalsecurity.org website. Night Vision Goggles (NVG).

<sup>5</sup> Harris, Kim. Director of Operations. Aviation Specialties Unlimited.

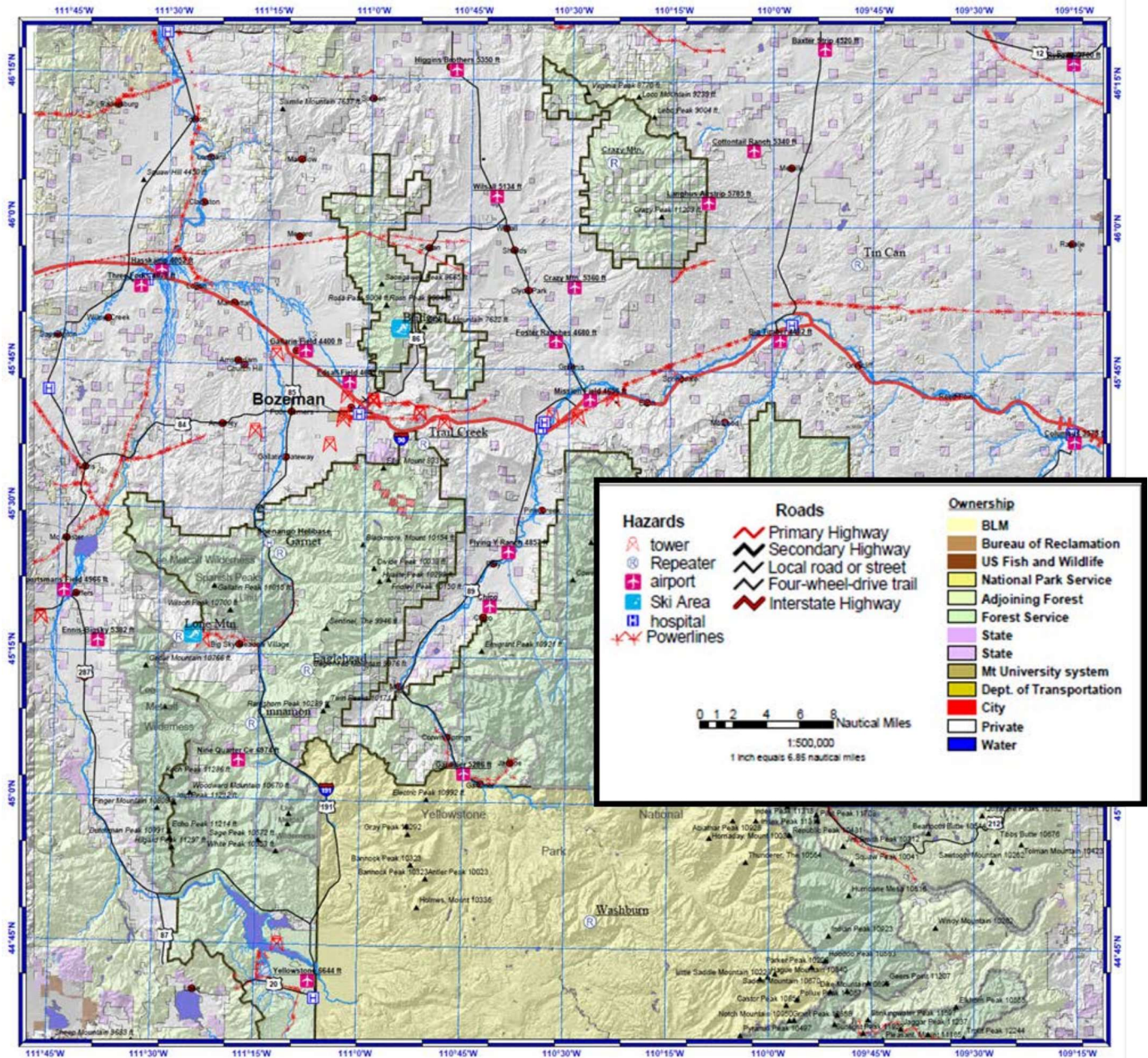

Figure 5- Aviation Hazard Map. Gallatin National Forest. U.S. Forest Service.

The following references (Boxes 1 and 2) provide some excellent considerations and reminders to be employed during all aviation mission-planning efforts:

**Box 1. HELICOPTER RESCUE- OPERATIONAL RED FLAGS**

1. Conducting a rescue with an unknown crew or aircraft
2. Exceeding the operating capabilities of the aircraft or crew
3. Improvising with an unpracticed or unrecognized technique
4. Communications issues (e.g. frequency incompatibility)
5. Becoming preoccupied with minor details
6. Inadequate leadership and failure to designate command
7. Fast operational tempo (i.e., “mission-itis” dictates operational decision making)
8. Failure to delegate tasks and assign responsibilities
9. Failure to communicate intent and plans



**Box 2. Twelve Standard Aviation Questions  
That Could Save Your Life**

1. Is this flight necessary?
2. Who is in charge?
3. Have all hazards been identified and have you made them known?
4. Should you stop the operation or flight because of:
  - Inadequate and unclear communications
  - Hazardous weather
  - Winds/Turbulence
  - Insufficient or untrained personnel
  - Conflicting priorities
  - Deceased rescue subject
5. Is there a better way to do it?
6. Are you driven by an overwhelming sense of urgency?
7. Can you justify your actions?
8. Are other aircraft in the area?
9. Do you have an escape route?
10. Are any rules being broken?
11. Are communications getting tense?
12. Are you deviating from the assigned operation or flight?

Rescue helicopter resources are typically categorized as public safety aircraft, helicopter EMS (HEMS), call when needed (CWN) commercial aircraft, and military aircraft. The following list (Table 1) displays the helicopter “typing” categories, based upon size, used for incidents involving the incident command system (ICS);<sup>6</sup>

<sup>6</sup> NWCG, Interagency Helicopter Operations Guide, chapter 6.

**Table 1- Helicopter Resource Typing**

	<b>TYPE I (Heavy)</b>	<b>TYPE II (Medium)</b>	<b>TYPE III (Light)</b>
	 <b>Sikorsky HH-60G Pave Hawk.</b> 210 <sup>th</sup> Rescue Squadron training over Alaska. USAF photo.	 <b>Eurocopter EC 145.</b> Travis County Starflight, Texas. Courtesy photo.	 <b>Eurocopter AS350 B3.</b> California Highway Patrol Aviation Unit- Apple Valley. NPS photo.
<b>Passenger Seats</b>	15+	9-14	4-8
<b>Allowable Sea Level Payload At 59° F. (544 Kg)</b>	5000 pounds (2268 kg)	2500 pounds (1134 kg)	1200 pounds (544 kg)
<b>Example Aircraft</b>	Bell 214, Sikorsky S-70 (UH-60/HH-60) Black Hawk, Augusta-Westland AW 139, Sikorsky S-64 Skycrane, Boeing-Vertol BE-234, Boeing CH-47	Bell 212, Bell 412, Eurocopter EC-145, Eurocopter UH-72 Lakota	Bell Long Ranger L-3, Bell 407 Eurocopter AS350 B3, Eurocopter EC-135, MD500, MD900 Explorer

## Risk Management Process

Assessing the perceived risk associated with an assignment as well as managing that risk to a practical level involves a multi-step process;<sup>7</sup>

1. **Situational Awareness-** knowledge, information, and perception of environment
2. **Hazard Assessment-** identification of risk and associated danger
3. **Hazard (Risk) Controls-** risk mitigation measures applied
4. **Decision Point-** Go/No-Go decision
5. **Evaluate-** monitoring

These five steps of the risk management process should be viewed as a cyclic process (Figure 6). Upon reaching the fifth step of evaluating and monitoring the operation, personnel should return to the first step, so that they are actually improving their situational awareness by updating their “mental image” of the mission with more accurate updated information. This moves personnel forward in a continuous loop, which permits them to react to the dynamic changes occurring on an incident.

<sup>7</sup> NWCG- Incident Response Pocket Guide, page 1.

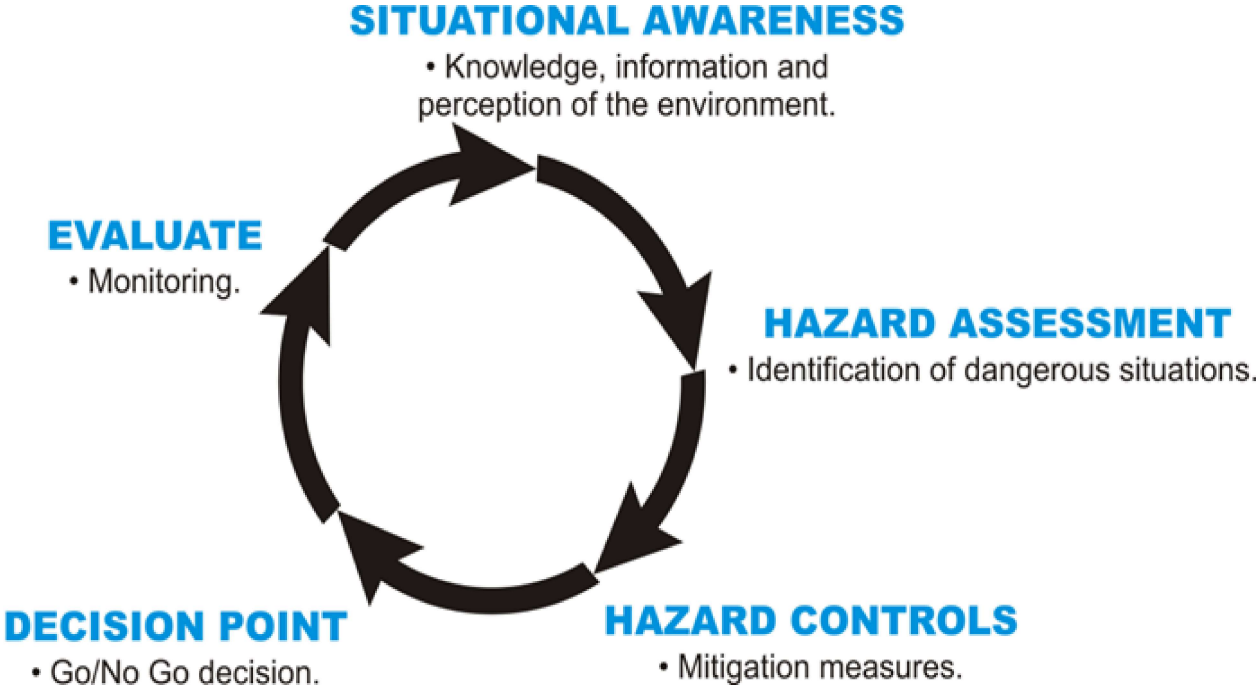

Figure 6- Risk Management Process.

### U.S. Coast Guard and Operational Risk Management

The U.S. Coast Guard (USCG) has a long tradition of conducting hazardous SAR operations in the maritime environment. Unfortunately, between 1991 and 1993 they experienced four major marine mishaps, which caused the National Transportation Safety Board (NTSB) to issue a recommendation for the agency to implement a more formal risk assessment training program. As a result, in 1996 the USCG executed a systematic process to continuously assess and manage risks, known as “Operational Risk Management” (ORM). ORM identifies and controls risks in all activities by applying appropriate management policies and procedures. As an operation progresses and evolves, personnel should continuously employ the following key operational risk management principles:<sup>8</sup>



<sup>8</sup> U.S. Coast Guard. “Operational Risk Management.” Commandant Instruction 3500.3.



**1. Accept No Unnecessary Risk:** SAR operations entail risk. Unnecessary risk conveys no commensurate benefit to safety of a mission. The most logical courses of action for accomplishing a mission are those meeting all mission requirements while exposing personnel and resources to the lowest possible risk.

**2. Accept Necessary Risk When Benefits Outweigh Costs:** The process of weighing risks against opportunities and benefits helps to maximize unit capability. Even high-risk endeavors may be undertaken when decision-makers clearly acknowledge the sum of the benefits exceeds the sum of the costs.

**3. Make Risk Decisions at the Appropriate Level:** The appropriate level to make risk decisions is that which most effectively allocates resources to reduce the risk, eliminate the hazard, and implement controls. This includes ground rescue personnel scrutinizing their own plan to request a helicopter rescue and whether it is truly appropriate. Incident personnel developing a plan of action must ensure subordinates are aware of their own limitations and when to refer a decision to a higher level.

**4. Integrate ORM into Operations and Planning at All Levels:** While ORM is critically important in an operation's planning stages; risk can change dramatically during an actual mission. Incident personnel should remain flexible and integrate ORM in executing tasks as much as in planning for them.

### **GAR Risk Assessment Model**

The USCG employs a remarkably effective ORM tool referred to as the GAR (Green-Amber-Red) Risk Assessment Model, which creates a GO-NO GO decision tool. The GAR Model incorporates the opinions of multiple involved personnel, whereas other planning tools may only incorporate input from one person.

GAR respondents independently assign a personal risk score to eight different elements associated with a mission. The risk score is **0** (No Risk) through **10** (Maximum Risk), which is a personal estimate of risk.

The following elements are evaluated in the GAR Model:

- **SUPERVISION-** The presence of qualified, accessible, and effective supervision on the incident. A clear chain of command is in place.
- **PLANNING-** Adequate incident information is available and clear. There is sufficient time to plan, operational guidelines are current, briefing of personnel is being conducted, and team input solicited.
- **CONTINGENCY RESOURCES-** Backup resources available that can assist if needed. Evaluate shared communications plan and frequencies. Has an alternative plan been evaluated?

- **COMMUNICATION-** Evaluate how well personnel are briefed and communicating. How effective is communication system and is there is an established communication plan? Does operational environment value input from all involved?
- **TEAM SELECTION-** Team selection should consider the qualifications and experience level of the individuals. Consider the experience for the mission being performed.
- **TEAM FITNESS-** Consider physical and mental state of the crew. Evaluate team morale and any distractions.
- **ENVIRONMENT-** Consider factors affecting performance of personnel and equipment such as time, temperature, precipitation, topography, and altitude. Evaluate site factors such as narrow canyons, forest canopy, technical terrain, snow, swiftwater, etc.
- **INCIDENT COMPLEXITY-** Evaluate the severity, exposure time, and probability of mishap. Assess difficulty of the mission and proficiency of personnel.

Several members of a team should individually complete GAR scores for a planned task without input from fellow team members. The individual risk scores are summed to come up with a Total Risk Score. If the total score falls in the green zone (1 - 35), then the risk is rated low and the mission is considered a “go.” A score in the yellow zone (36 - 60) indicates moderate risk and additional mitigations or controls should be put in place before proceeding with the mission. If the total score falls in the red zone (61 - 80), the risk is significant and this indicates a “no go.” Upon completion they review their results together.<sup>9</sup>

<b>GAR RISK ASSESSMENT SCORE</b>		
<b>1 - 35</b>	<b>36 - 60</b>	<b>61- 80</b>
<b>GREEN</b> GO- Proceed With Mission	<b>AMBER</b> Caution- Mitigate Hazards Before Proceeding	<b>RED</b> NO GO- Stop- Do Not Proceed With Mission

**Why this procedure really works...** The ability to assign numerical scores or color codes in the GAR Model is not the key ingredient in how this process serves to perform effective risk assessment. The key ingredient occurs when team members discuss their post-scoring results together, because it generates valuable discussion toward understanding the risks and how the team will manage them. Ultimately, it slows down the operational tempo and forces rescuers to carefully think rather than simply react.

<sup>9</sup> U.S. Coast Guard. “Operational Risk Management.” Commandant Instruction 3500.3.

## Public Aircraft Regulations- FAA

Helicopter rescue operations are governed by the statutory regulations of the Federal Aviation Administration, which are the Federal Aviation Regulations (FAR) in Title 14 of the Code of Federal Regulations (CFR).

### Public Aircraft

Public aircraft are considered by the FAA to be those owned or leased by the federal, state, or a local government agency. Previously it was considered public aircraft operations could not involve compensation between government entities, as it would place the aircraft “for hire” in the civil aircraft (Part 135 operations) category. The Independent Safety Board Act Amendments of 1994, (Public Law 103-411) clarified the definition of public aircraft and held that one government agency could receive compensation for providing aircraft services to another government agency. Furthermore, it does not include public aircraft transporting passengers—*“other than when transporting crewmembers or other persons aboard the aircraft whose presence is required to perform, or is associated with the performance of, a governmental function such as firefighting, search and rescue, law enforcement, aeronautical research, or biological or geological resource management.”*<sup>10</sup> Ultimately, the status of a “public aircraft” depends on its use within government service and the type of operation being conducted at the time. The European equivalent of the FAR is the Joint Aviation Regulations (JAR), which has no such provision for public aircraft.<sup>11</sup>

### Rotorcraft External Load Operations- Public Aircraft

Of particular interest to most rescue agencies is FAR Part 133, Rotorcraft External Load Operations, specifically section 133.1, which exempts “a federal, state, or local government conducting operations with public aircraft” from the rotorcraft regulations. According to the FAA, *“agencies which conduct public aircraft operations are encouraged to comply with the Federal Aviation Regulations (FAR), even when they not required to do so.”*<sup>12</sup> The FAA designates rotorcraft-load combinations as Class A through Class D. “Class D” refers to rescue operations in which the human external cargo (HEC) is suspended below the helicopter.

If a private operator (non-public aircraft) were to consider conducting a short-haul operation, another obstacle exists in the form of Part 133.45(e) 1-4, which requires the use of a twin-engine aircraft with “hover capability with one engine inoperative at that operating weight and altitude.” In addition, aircraft-to-rescuer communications are required, along with an FAA-approved “personnel lifting device” that has an emergency release that requires two distinct actions. “FAA approved” means that a piece of equipment, such as an anchor point, has received a supplemental type certificate (STC) or a technical standard order (TSO) verifying that it does not affect the airworthiness of the aircraft.

---

<sup>10</sup> FAA, Government Aircraft Operations

<sup>11</sup> Joint Aviation Authorities, JAR OPS3

<sup>12</sup> Federal Aviation Administration, Government Aircraft Operations. Advisory Circular 00-1.1.

FAR Part 133.31, Emergency Operations (a), states, “In an emergency involving the safety of persons or property, the certificate holder may deviate from the rules of this part to the extent required to meet that emergency.” The intent of this regulation is not to give rescue organizations, when confronted with a life-threatening emergency on the ground, clearance to violate FAA rules in order to accomplish a mission. It is important to understand that Part 133.31(a) refers to in-flight emergencies and the helicopter pilot’s deviation from rules to handle such an emergency.<sup>13</sup> Rescue organizations unfortunately have sometimes interpreted this regulation as a loophole that allows them to improvise a helicopter rescue operation. However, the fact is, such a practice removes the critical need for advanced training, and crews may end up carrying out a mission without the requisite proficiency and risk management.

## **Mission Management**

The success of a mission is directly related to how well it is organized and managed. Establish an adequate incident management structure through the incident command system (ICS) for the identified response. To achieve this, the role of command must be clearly identified to all personnel; an adequate span of control must be maintained to prevent task overload; and staffing positions must be filled with trained, qualified rescue workers. For large scale responses, activate the positions of air support group supervisor, helibase manager, and helispot manager to coordinate the arrivals and departures of numerous helicopters. This type of positive control of aviation assets prevents the incident from turning into an unmanaged “air show,” in which pilots and air crews are forced to operate without direction.

## **Flight Following**

Flight following is a positive system of tracking aviation assets. It provides an operational safety net in the event a rescue helicopter becomes overdue during a mission. The aircraft’s position is reported automatically through its GPS and an onboard satellite modem or alternatively by a crewmember at least hourly (every 15 minutes is preferable) to a dispatch center, air traffic control, or incident command (air operations branch if available). This provides a last known point from which to start search efforts, thereby reducing the response time to reach personnel who may be injured.

## **Crew Resource Management**

Flight crew actions or “human factors” were the primary casual factor in 70% of significant commercial jet aviation accidents occurring 1959-1989.<sup>14</sup> This directly lead to the development of a training program known as Cockpit Resource Management (CRM) or “crew resource management” as the concept began to involve personnel outside of the flight deck. CRM is also useful outside the aviation industry and has been found to be highly effective for improving team performance in any high-risk environment. CRM directly addresses the errors caused by poor group decision-making, ineffective communication, inadequate leadership, and poor task or resource

---

<sup>13</sup> Harrington, Nick. Aviation Safety Inspector. Federal Aviation Administration.

<sup>14</sup> Wiener, Earl, Barbara Kanaki, and Robert Helmreich. Cockpit Resource Management, page 5.

management. A team employing effective CRM utilizes open communications, briefings, team member advocacy, crew monitoring, crosschecking, task vigilance, effective workload management, improved situational awareness, fatigue and distraction avoidance, and promotes an environment of self-critique.

Good CRM relies on the dedicated actions of people, which are unfortunately not without flaws. A breakdown in effective CRM repeatedly leads to accidents. During helicopter rescue operations, effective CRM needs be achieved not only amongst the flight crew but also extend well beyond the aircraft to include communications personnel (dispatch), ground rescuers, incident command staff, and additional responding agencies. One of the best means to practice good CRM is through effective and professional communication strategies, which eliminate confusion and avoid assuming information has been adequately shared. The importance of several of the communications techniques found within this text, such as conducting briefings and utilizing direct statements all contribute back to improved CRM.

## Communications

Clear precise communications eliminates the pitfalls that have jeopardized many missions. Common hand signals (Figure 6) are useful when combined with radio transmissions, because they are instantly understood and avoid the problems of garbled messages and radio frequency congestion. However, pilots who are not familiar with or confident of the ground personnel using the hand signals may ignore the signals or rely on their own best judgment instead. Working and training in advance builds the necessary trust and familiarity between aircrews and ground rescuers.

Emergency responders must have reliable communication equipment and possess effective personal communication skills. Communication is everything on a SAR operation. Without “*good comm*,” safety is quickly jeopardized as personnel accountability is lost and responders begin free-lancing without specific direction. As stated previously, the sharing of critical information provides an accurate mental model for personnel. Flight crews adhere to a “sterile cockpit,” refraining from non-essential or extraneous conversation, during critical phases of flight (e.g. landing, take-off, hover, hoist operations, etc.). Crewmembers should be taught to violate this mandate if they have urgent safety-related communication required for the safe operation of the aircraft.

### Five Communication Responsibilities for All Personnel:<sup>15</sup>

1. Brief Others As Needed
2. Debrief Your Actions
3. Communicate Hazards To Others
4. Acknowledge Messages
5. Ask, If You Don't Know

---

<sup>15</sup> NWCG, Incident Response Pocket Guide, page ix.

## Hand Signals

Hand signals are vital since they can provide an immediate backup technique in the event of a communication failure. Standardized hand signals used by federal land management agencies (Figure 7) as well as by the U.S. Navy (Table 2) can provide an instant means of communication that is not subject to interference from other sources like radio transmissions. The effectiveness of hand signals is hampered by lighting and distance. Ground rescue personnel should give hand signals in a large and exaggerated manner to prevent misinterpretation by the flight crew.



Figure 7- Interagency Helicopter Hand Signals. Source; Interagency Helicopter Operations Guide (IHOG). NFES 1885

Table 2. US Navy- Team and Helicopter Signals	
MEANING	ACTION
Affirmative	Thumbs Up
Cease Operations	Slashing Motion Across Throat
Deploy Medical Kit	Crossed Wrist
Deploy Backup Swimmer	Breast Stroke Motion
Deploy Raft	Paddling Motion
Deploy Stokes Litter	Hands Cupped Then Arms Out-stretched
Deploy rope ladder	Fists Shoulder Width Apart, Climbing Motion
Emergency	MK-13/124 Flare and/or Overt Strobe
Helicopter Move In/Out	Wave In/Out
Lower Rescue Cable Without Device	Climbing Rope Motion
Lower Penetrator/Device	One Arm Extended Overhead Fist Clenched
Parachute nearby	Closed Fist, Pumping Arm, Point With Other Arm
Ready for Pickup	Arms Waving/Strobe
Raise Cable	Thumbs Up/Chemlight Pumping Motion
Sharks	Hand-Clapping Motion
Team Recall	Circling Arm Over Head Finger Pointing Skyward
Unable to Recover Must Depart	Flashing Landing Light
Movement of Aircraft	Direction of Palm

*Source: Navy SAR Manual 3-50.1, 2009 edition*

## Using Direct Statements

Emergency responders often observe operational hazards during an incident, however they fail to speak up to initiate getting them corrected. In situations involving critical communication, it is most effective to use direct statements. Although they appear rude, direct statements are difficult to ignore and are very productive.

The following are the six components of direct statements:

1. Address the person to whom you are talking by name.
2. Begin with, "I," "I think," "I believe," or "I feel."
3. State your message or solution as clearly as possible.
4. Use the appropriate emotion for your message so that it's delivered as you intended.
5. Require a response by using such statements as "What do you think?" or "Don't you agree?"
6. Don't let the matter go. Don't disengage with the other person until you achieve agreement or buy-in.

An example of a direct statement might be, "*Jane, I think we need to move personnel away from this hazardous location. Don't you agree?*"

It may sound elementary, but this technique is surprisingly effective. A direct statement gets the person's attention and forces the individual to deal with your concern rather than allowing him or her to ignore your message.

## Briefing Personnel

When we work together in a small team during an emergency, our ability to share information and develop a "*shared mental image*" is the key to effective teamwork. The incident commander must adequately communicate their intent and plans to other rescuers. The following checklist (Box 3) provides an effective means for communicating a plan in critical circumstances.

### Box 3. EMERGENCY BRIEFING FORMAT

1. Here's what I think we face
2. Here's what I think we should do  
(Assignments, communications, and contingencies)
3. Here's why
4. Here's what we should keep our eye on
5. Now, talk to me

Adapted from Dr. Karl Weick, South Canyon Revisited: Lessons Learned From High Reliability Organizations.

The strength of this concise briefing format is found in the last line. When we openly solicit feedback from team members with an open-ended statement we create a culture that encourages communication. This is far different from asking, "any questions?"

## Multi-Tasking

During a challenging rescue it is easy to quickly become "over-tasked." We falsely believe that we are good at multi-tasking, which is more accurately described as "concurrent task management."<sup>16</sup> The reality is that we are prone to errors while attempting to manage multiple tasks. For example, while completing a procedural checklist, we may fail to complete an intermediate task, due to being distracted by someone asking a question. An increased workload often results in the "omission of crucial task elements, along with loss of situation awareness and poor decision making."<sup>17</sup>

### Failure to manage concurrent tasks effectively occurs through;<sup>18</sup>

1. Interruptions and distractions
2. Tasks that cannot be conducted in the practiced sequence
3. New tasks arise unexpectantly
4. Multiple tasks that must be performed concurrently

<sup>16</sup> Loukopoulos, Loukia, R. Key Dismukes, and Immanuel Barshi. The Multitasking Myth, page 11.

<sup>17</sup> Ibid, page 20.

<sup>18</sup> Ibid, page 106.



**Distractions from a primary task can occur through;**

- Radio traffic
- Conflict
- Previous errors
- Collateral duties
- Incident within an incident

Inattentional blindness, which is “looking without seeing”, causes us to fail to notice an unexpected stimulus in our field of vision when other attention-demanding tasks are being performed. How can a trained rescuer walk into a spinning helicopter rotor? It happens because humans become overloaded with stimuli, and it is impossible to pay attention to all stimuli in one's environment.

Recognizing the risk associated with interruptions and distraction can assist

a person in being cautious when they need to interrupt someone else. Ask team members for assistance in monitoring and crosschecking (Figure 8). Use checklist, visual cues, reminders and monitoring to safeguards against errors of omission.



**Figure 8- Avoid distractions.** Use team members effectively for monitoring and crosschecking. Two rescuers, well-equipped for the extreme conditions of a high altitude rescue operation, conduct short-haul training at Denali National Park & Preserve. Image copyright Menno Boermans.

## Landing Zones

The urgency of a helicopter rescue can result in flight and/or ground crews utilizing a landing zone that is less than adequate, typically because of the proximity to an accident scene. This action has directly resulted in rotor strikes with terrain, vessels, cables, wires, foreign object debris and tragically, rescue personnel on the ground.<sup>19</sup> Select an adequately sized landing zone, based upon the type helicopter being employed (Table 3).

<sup>19</sup> Phillips, Ken. Unpublished analysis of Helicopter Rescue Accidents- IKAR

Table 3. Landing Zones Specifications

Helicopter Type	Type I	Type II	Type III
<b>Touchdown Pad Dimensions</b>	30 feet X 30 feet (9 m X 9 m)	20 feet x 20 feet (6 m X 6 m)	15 feet X 15 feet (4.6 m X 4.6 m)
<b>Safety Circle Diameter</b>	110 feet (33.5 m)	90 feet (27.4 m)	75 feet (22.8 m)

Source; Interagency Helicopter Operations Guide (IHOG). NFES # 1885

Factors that must be considered during a wilderness helicopter rescue include winds, dust and snow covered terrain (Figure 9). Winds can be extremely variable in the mountain environment and a visual indication of speed and direction can be very useful for the pilot. A windsock, flagging, smoke signal, or dirt thrown into the air as the helicopter initiates a high orbit over the scene can serve as a wind indicator. A helicopter achieves optimum performance when landings and takeoffs are made into the direction of the oncoming wind. Ground rescuers should anticipate this in their selection of a landing zone and in the staging of rescue apparatus or personal equipment.



**Figure 9- Helispot Landing.** Helicopter evacuation of ill climber at 14,200 feet (4,328m) elevation being conducted by National Park Service rescuers at Denali National Park & Preserve with contract AS350 B3 helicopter. Image copyright Menno Boermans.

## Rotor Wash

Management of dust by wetting down the landing surface or snow by compaction can minimize the amount of blowing particles that reduce visibility during landings and take offs. The rotor wash from an unmanaged dust or snow covered landing zone could result in a brownout or whiteout as the aircraft attempts touchdown, resulting in spatial disorientation for the pilot. In Iraq and Afghanistan, brownout was a critical concern with it being responsible for three out of every four U.S. military helicopter accidents.<sup>20</sup> A landing zone covered in tall grass may contain hidden hazards, such as large rocks, and the grassy surface can develop wavelike motions resulting in disorientation for the pilot.

<sup>20</sup> Wadock, Alan J., et al. Downwash Flow Field Study\_, page 1.

The concern of increased rotor wash (downwash) from larger aircraft (Figure 10) is a significant hazard to ground rescuers, which should be carefully evaluated in mission planning. The potential exists for an unsecured rescuer in technical terrain being struck by powerful rotor wash or the associated propelled debris. This situation claimed the life of a park ranger during a hoist rescue at Mount Rainier National Park on June 21, 2012, while he worked 50 feet beneath a CH-47 Chinook on an icy 35° slope<sup>21</sup>. Consciously evaluate if the aircraft being employed will create unnecessary risk with the increased rotor wash in the specific rescue environment and what specific actions can be taken to reduce this hazard.

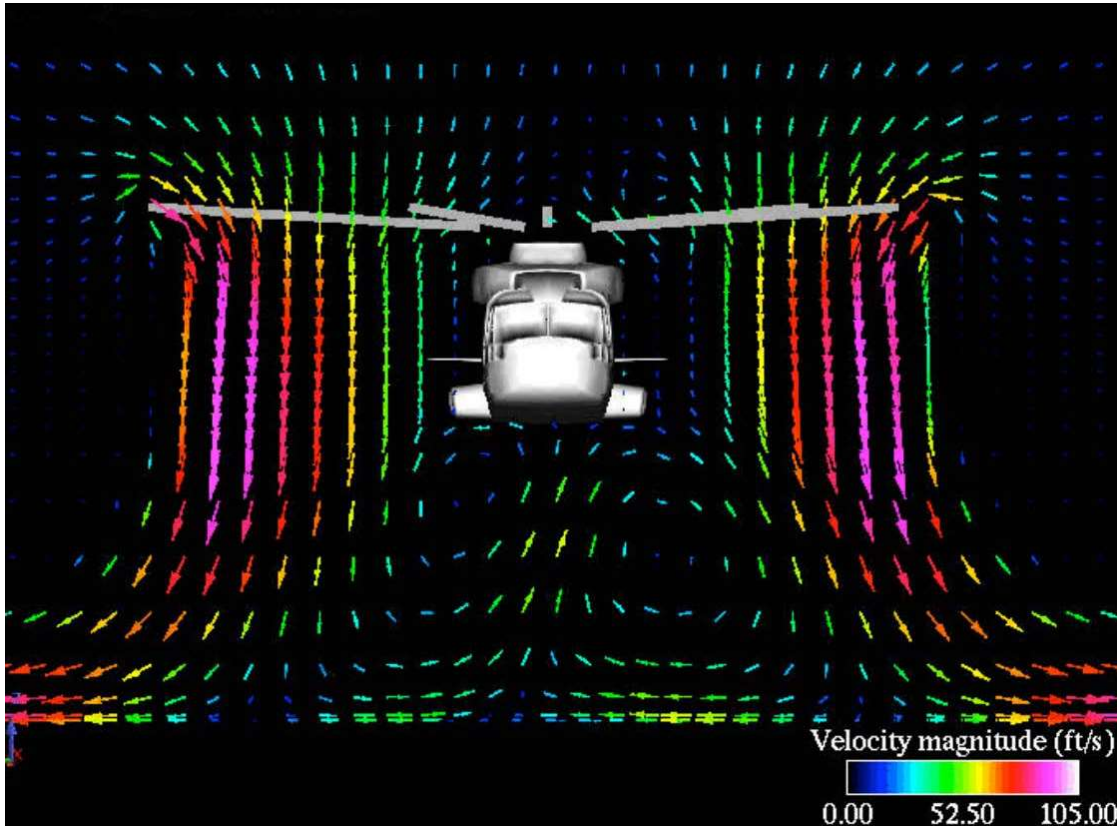

**Figure 10- Rotor Outwash Study.** Velocity vectors from rotor outwash are shown in a transverse plane for the EH-101 (AgustaWestland AW101) Merlin Helicopter. It is important to note that the greatest velocities are generated near the rotor tips. Source: Rotorcraft Downwash Flow Field Study to Understand the Aerodynamics of Helicopter Brownout by Alan Wadcock et. al. Reprinted with permission of the author.

## Hot Loading

Hot loading (engine running) or hot off-loading of a helicopter sometimes may be required for efficiency, such as for crew shuttles and power-on landings. However, remember that this practice poses greater risk for personnel particularly from possible rotor droop if engine RPM is reduced. Anticipate the situation and secure loose debris and gear in advance. Shutting down the aircraft to load personnel or a rescue subject dramatically reduces the risk and increases the safety of everyone working near the aircraft.

<sup>21</sup> NPS. Serious Accident Investigation-June 21,2012.

**Additional landing zone considerations:**

- Avoid landing zones where maximum performance takeoffs are required.
- Any wind indicator being employed at the site must be secure.
- A landing zone with significant sloping terrain should be avoided.
- Anticipate a shift in wind direction with a site that permits an aircraft being able to maneuver into the wind.

**DoD Landing Zone (LZ) Radio Call- “STOPWWW”**

- S- Size (100 X 100 feet [30m X 30m])
- T- Terrain
- O- Obstacles
- P- Power= Elevation
- W- Winds
- W- Waive Off
- W- Weight

Note: refer to Appendix F for DoD landing zone requirements.

## Aircraft Weight and Balance

It is vital to comply with weight and balance limits established for a helicopter. Operating above the maximum weight limitation compromises the structural integrity of the helicopter and adversely affects performance. Balance is also critical because on some fully loaded helicopters, center of gravity (CG) deviations by a few inches can dramatically change a helicopter’s handling characteristics. To determine the weight and balance, a helicopter manufacturer calculates the longitudinal and lateral CG envelopes of a helicopter so that in a loaded manner there is sufficient cyclic control for all flight conditions<sup>22</sup>.

## Load Calculation

To ensure that a helicopter is not exceeding maximum gross weight (equipped weight plus entire load), a load calculation should be prepared before any mission. The Department of the Interior (DOI) and U.S. Forest Service (USFS) use an Interagency Helicopter Load Calculation Form (NFES #1064), which is completed by the pilot (Figure 11). The military employs a Performance Planning Card, which are specific to the model of aircraft.

This might be viewed as an unnecessary delay during an emergency operation, however the completion of an accurate load calculation is an essential flight planning tool. Pre-weighing SAR equipment and clearly marking this weight on the outside of the bags, streamlines payload calculations during an operational response. In determining if a helicopter is within the weight limits, you must consider the weight of the basic helicopter, crew, passengers, cargo, and fuel.

---

<sup>22</sup> FAA Rotorcraft Flying Handbook, chapter 7



### **Important Load Calculation Reminders**

Perform a new load calculation when environmental conditions change, as with:

- Plus or minus 5° C (41° F) in temperature
- Plus or minus 1,000 ft. (305 m) in altitude
- A significant change in the fuel load

During agency incident operations, the pilot-in-command (PIC) should be kept informed of altitudes and temperatures aircraft will be expected to operate, so that out-of-ground effect allowable payloads can be calculated. When military aircraft are employed, agency helibase personnel are responsible for providing the military crew chief with an accurate manifest of passengers and cargo. For complex missions requiring numerous insertions of personnel, military aircrews may utilize an Assault Support Serial Assignment Table (ASSAT) or Assault Support Landing Assignment Table (ASLAT) as planning documents to plan the manifest for each load.

### **Helicopter Rescue Crew Configuration**

The benchmark of a highly functioning helicopter crew is shared mental image, which allows members to share knowledge and work together in a coordinated fashion. The exact crew configuration varies based on the agency and aircraft size. However, most rescue helicopter crews include the following:

- Pilot: The PIC conducts all activities related to flying the helicopter.
- Copilot/helicopter manager: The copilot (i.e. pilot not flying- more precisely known as “pilot monitoring”) or the helicopter manager is responsible for performing en route navigation and communication tasks. The copilot serves as second in command of the aircraft during flight operations.
- Operations chief/crew chief/spotter: This crewmember is responsible for all operations in the aft cabin of the helicopter (e.g. hoist operations).
- Rescuer/HEMS crewmember: This crewmember performs rescue tasks related to hoist, short-haul, helicopter rappel operations, and/or patient care. Once on the ground at the rescue site, this person becomes a link between ground rescuers at the scene and the aircraft.

### **Pilot Responsibility**

The final authority regarding any aircraft is always the PIC. This authority is provided by 14 CFR part 91.3(a), which states that the “pilot in command of an aircraft is directly responsible for, and is the final authority as to, the operation of that aircraft.”

In a two pilot aircraft, the PIC concept fails to capture the role and responsibility of the other pilot in the cockpit (Figure 12). The term Pilot Flying (PF), identifies the pilot who has responsibility for flying the aircraft for a segment of flight. The other pilot is designated as 'Pilot Not Flying' (PNF) or more accurately 'Pilot Monitoring' (PM). The role of the PNF is to monitor the flight management, aircraft control actions of the PF, and carry out support duties such as communications and check-list reading.

## Helicopter Flight Characteristics and Limitations

A basic understanding of the flight characteristics of helicopters can allow ground rescuers to make more informed decisions regarding rescue plans.

### Helicopter Aerodynamics<sup>23</sup>

The main rotor blades on a helicopter rotate in a horizontal circular area and act as “wings” or airfoils to create lift for the helicopter. Landing into the wind aids this aerodynamic principle, because with the increased wind velocity over the airfoil, less power is required to achieve the same amount of lift. This is an important concept for ground rescuers to understand, because a pilot will attempt to land and take off into the direction of the oncoming wind.



**Figure 12- Two pilot configuration.** Two USAF 41st Rescue Squadron pilots fly an HH-60G Pave Hawk during training at Moody Air Force Base, GA. U.S. Air Force photo, Airman 1st Class Benjamin Wiseman.

Flight controls employed by the pilot include anti-torque floor pedals, collective, and cyclic (Figure 13). The rotational motion of the rotor blades generates torque in the opposite direction. A tail rotor or adjustable jet thruster in the tail boom, controlled by floor pedals, provides anti-torque control to compensate and prevent the helicopter from

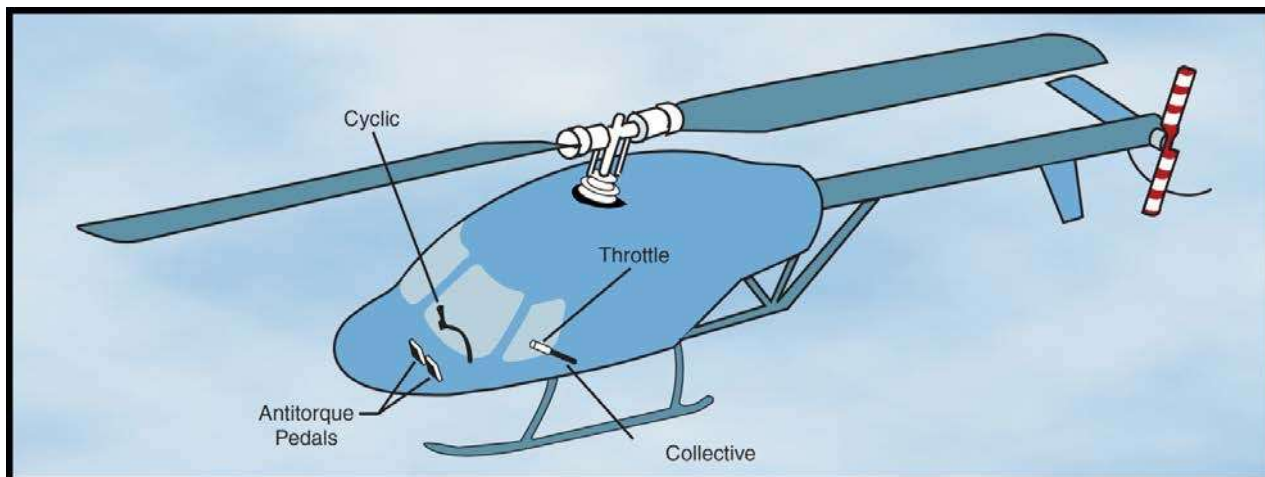

**Figure 13- Helicopter Flight Controls.** Three primary helicopter flight controls include cyclic, collective, and anti-torque foot pedals. Image courtesy FAA.

<sup>23</sup> FAA Rotorcraft Flying Handbook, chapter 3

spinning out of control. The pilot can vary the pitch of the main rotor blades to permit the helicopter to climb or descend through the use of the collective pitch control while the cyclic control, located between the pilot's legs, directs the forward, backward, and sideways movement of the helicopter through corresponding tilting of the rotor disc.

## Ground Effect

The proximity of the helicopter to the ground can result in increased lift from the interaction of the rotor downwash with the ground. Hover in ground effect (HIGE) typically occurs one half the rotor diameter above the surface, where the ground interrupts the airflow under the helicopter, and the velocity of the induced airflow to the rotor system is reduced (Figure 14). The result is less induced drag and more vertical lift. This ground effect is beneficial in flight because it increases the lift capability of the helicopter, which consequently requires less power to maintain a hover. Ground effect is less effective when positioned over uneven terrain, vegetation, water, or high grass because these surfaces absorb some of the downwash energy beneath the rotor disc.

As a helicopter climbs away from the ground surface it loses this effect of increased lift. Hover out of ground effect (HOGE) occurs at an altitude high enough that the added benefit of ground effect is not obtained.

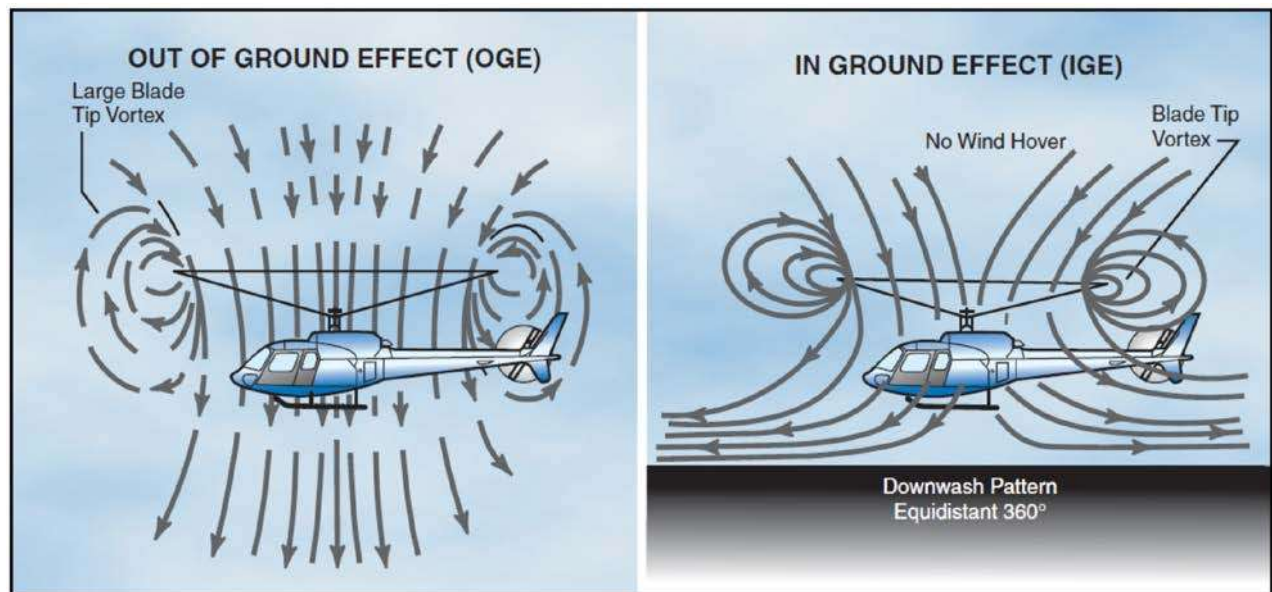

**Figure 14- Ground effect.** Air circulation patterns change when hovering out of ground effect (HOGE) and when hovering in ground effect (HIGE). Image courtesy FAA.

## Autorotation

Autorotation allows a helicopter to land safely, within defined limits, if the engine fails in flight. Helicopters have a freewheeling unit in the transmission which automatically disengages the engine from the rotor system in the event of failure, permitting the main rotor to spin freely. As the helicopter descends, the airflow is upward through the rotor system, causing a windmilling of the blades. By changing the pitch of the blades, the pilot can maintain constant rpm. The pilot slows the aircraft using the stored blade



inertia and can cushion the helicopter to a landing. The required airspeed for successful autorotation varies based on altitude and helicopter type. For most light, single engine helicopters this minimum height, as in a hover, is 350 to 450 feet (107 to 137 m) above ground level.<sup>24</sup> This has serious implications for all helicopter rescue personnel, because the low-altitude hovers used for hoisting, short-haul, and rappelling operations all occur within the cautionary portions of the height-velocity curve charts.

## **Translational Lift**

Translational lift is the additional lift generated as the helicopter transitions from a hover to horizontal flight. This additional lift comes from the increased efficiency of the rotor system, which generates more lift in forward flight, as a result of higher in-flow velocity of air mass than during a hover.

## **Density Altitude**

Density altitude (DA) provides a measure of the air density corrected for temperature and humidity variations at altitude. The DA greatly affects a helicopter's performance. At lower elevations, the rotor blade cuts through denser air, which provides better performance than the air at higher altitudes. At an altitude of 10,000 feet (3,048m), for example, there are fewer air molecules per cubic foot of air, which results in diminished performance. An increase in humidity has a minor effect on DA when compared with an increase in the altitude or temperature. Aircraft performance charts therefore commonly reflect only air temperature and pressure altitude. To understand the dramatic effects of DA, consider that on an 80° F (27° C) day at 8,000 feet (2,438m), the higher DA causes the aircraft to perform as if it were at 11,100 feet (3,383m)!

## **Hover Ceiling**

The hover ceiling is the highest altitude at which a helicopter can successfully hover while loaded to its maximum gross weight. In and out of ground effect hover ceilings are computed at maximum gross weight.

## **Center of Gravity**

The CG is the point in a helicopter where all forces are balanced, typically under the rotor mast. This is a critical balance for safe flight, and it is effected by the distribution of the weight of fuel, personnel, and cargo in the helicopter.

## **Helicopter Landings**

From a risk management perspective, the preferred helicopter landing is a full touchdown landing at a suitable flat landing zone clear of obstructions. This method poses less risk to the aircrew and ground rescuers. In some situations, higher risk landing techniques must be utilized:

---

<sup>24</sup> Department of the Interior, Basic Aviation Safety, p.8

## Slope Landings

Landing across a slope of 5° is considered the maximum for normal operation of most helicopters. Landing with the helicopter facing downslope increases the risk of striking the tail on the surface. The risk of landing across a slope is that a helicopter is susceptible to a lateral rolling phenomenon called dynamic rollover.

For dynamic rollover to occur, some factor must first cause the helicopter to roll or pivot around a skid or landing gear wheel, until its critical rollover angle is reached. If the critical rollover angle is exceeded, the helicopter rolls on its side regardless of the cyclic control corrections made. Dynamic rollover may also occur if the pilot does not use the proper landing or takeoff technique or while performing slope operations. Dynamic rollover can occur in both skid and wheel equipped helicopters, and all types of rotor systems.<sup>25</sup>

## One-Skid Landings

A one-skid landing is used in rugged terrain where the topography prevents a normal landing with both skids on the ground and the pilot may have to put a single skid or landing wheel alongside the slope to allow boarding or exiting. During the maneuver, the helicopter remains “in flight” at full power.

## Toe-In Landings

A toe-in landing is similar to a one-skid landing in that only the front tips of the skids make contact with the ground (Figure 15). One-skid and toe-in landings put the aircraft close to physical hazards. Although used by many agencies, these techniques require practice and are not a recommended option for most teams, especially those with only intermittent experience in helicopter operations. Additionally, this introduces a pivot point that could generate conditions resulting in dynamic rollover.



**Figure 15- Toe-In Landing.** Using a Eurocopter EC 135 T2, rescuers from the Italian rescue association Aiut Alpin Dolomites, conduct a toe-in landing near the Passo Sella in the Dolomites. Image copyright Mateo Taibon.

<sup>25</sup> FAA. Rotorcraft Flying Handbook, page 10-6.

## Hover Landings

Hover or step-out landings are utilized to drop off or pick up passengers and cargo while the helicopter is held in a hover. The helicopter is not in contact with the ground, and its CG can shift laterally and longitudinally.

## Power-On Landing

A less risky consideration for a marginal landing zone is a power-on landing, in which the pilot places both skids in full contact with the ground while running full power to maintain the position of the aircraft. This type of landing may be an operational consideration, where a minimal or sloping touchdown pad is bordered by a steep drop in terrain. It may be the preferred technique during snow landings where depth and firmness are unknown precluding powering down the helicopter.

## Basic Helicopter Safety

### Preflight Briefing

Before boarding a helicopter as a passenger, a preflight briefing from the pilot or aircrew, including the following information specific to the helicopter, is required:

- Personal protective equipment (e.g. Nomex® clothing, gloves and flight helmet)
- Approach and departure around aircraft
- Location of the first aid kit and any survival equipment
- Location and operation of the fire extinguisher, first aid kit and emergency location transmitter (ELT)
- Emergency electrical and fuel shutoff controls
- Operation of doors and seat belts
- Emergency procedures and exits

### Safety During Helicopter Operations

- Never approach the helicopter until the pilot or crew directs you to do so. Then, approach and depart from the side (45° or less) or front of the aircraft in a crouching position and in full view of the pilot. Do not walk toward the tail rotor.
- To avoid proximity to the main rotor, approach and depart on the down slope side of the aircraft. Do not walk uphill exposing yourself to the rotor system when departing from an aircraft or approach a helicopter by walking downhill toward the rotor blades.
- Use the door latches only as instructed. To avoid damaging fragile aircraft components, be cautious around Plexiglas and moving parts.
- Fasten your seat belt upon boarding the helicopter and leave it secured until the pilot signals for you to disembark. Fasten the seat belt behind you as you leave the aircraft.
- Secure loose clothing or equipment that could generate snag hazards.
- Keep landing areas free of loose debris that rotor wash may pick up.
- Do not throw items from the helicopter, because they could strike the rotor system.

- Provide visual wind indicators for landing and takeoff; stand at the edge of the landing zone with your back to the wind and your arms pointing at the touchdown pad.
- When working on the ground around a helicopter, wear eye and hearing protection, along with a helmet secured by a chin strap.
- When approaching or departing from aircraft, nothing should be carried above shoulder level.
- Secure all cargo placed aboard the helicopter; provide the pilot or aircrew with accurate weights.
- Hot loading of passengers or a rescue subject involves greater risk; always be alert when conducting such a maneuver. Consider reducing the risk when practical by shutting down the aircraft.
- Landing zones should have acceptable rotor clearance for the aircraft assigned to the incident, and all incident personnel should be aware of these clearance requirements.
- As a passenger, know the aircraft's location and have a mental plan for what to do in the event of a crash or in-flight emergency.
- While working on the ground beneath the helicopter, during hover phases, all rescue personnel must be aware of the aircraft's position and **maintain a constant vigilance upon the belly of the aircraft.**

#### RESCUE LINE ENTANGLEMENT

**All personnel involved in helicopter rescue should be made aware that accidents involving line entanglement have been catastrophic for flight crew and rescuers.**

Conscious efforts should be made by rescue personnel to prevent entanglement of a hoist cable, short-haul line, or rescue load on the line with fixed objects on the ground (Box 4). The extraction phase of a rescue operation should be treated as a critical phase of flight, with increased vigilance and mental preparation toward reacting to a problem.

#### BOX 4. LINE ENTANGLEMENT- CRITICAL SAFETY REMINDERS:

- Preventing line entanglement is paramount
- Brief in advance on emergency procedures
- Avoid attachment of helicopter directly to ground
- Keep the rigging at the bottom end simple
- Always double check attachment points
- Clear communication is vital
- Rescue extraction is a *“critical phase of flight”*

## Personnel Protective Equipment

The military, federal civilian agencies, and most public safety organizations have strict requirements for the personal protective equipment (PPE) that must be worn by the

crew and passengers aboard rescue helicopters. Although turbine-powered helicopters are highly reliable, the potential for crash and postcrash injuries still exists. For example, a common risk is a flash fire after the crash, therefore fire-resistant clothing is a necessity. Personal protective equipment required by DOI includes the following:

- **Fire-resistant clothing:** A loose-fitting flight suit or clothing made of fire-resistant material, such as Nomex® or Polybenzimidazole (PBI), helps protect against injuries from fire. The loose-fitting style provides an airspace between the fabric and the skin that acts as insulation against heat sources. Although the fabric reduces the risk or severity of tissue damage, it does not prevent thermal injury to the skin. Nomex® is a fire-resistant aramid fiber manufactured by the DuPont Corp, which does not melt or flow at high temperatures. Above 700°F (370°C), Nomex® will degrade rapidly to a friable char. At the point at which woven nylon fabrics melt (489°F, 254°C), fabrics woven of Nomex® fiber retain about 60% of their original strength.<sup>26</sup> PBI is a synthetic fiber produced by PBI Performance Products, Inc. PBI will not ignite, and retains fiber integrity in addition to suppleness when exposed to flames. It does not have a melting point but has a decomposition temperature  $\geq 1300^{\circ}\text{F}$  ( $700^{\circ}\text{C}$ ).<sup>27</sup> The heat transfer through any fire-resistant material could be high enough to melt synthetic undergarments (e.g. polypropylene or Capilene); therefore these fabrics should not be worn next to the skin during flight operations. Natural fiber garments, such as wool, cotton, and silk are preferred. Polartec® Thermal-FR®, developed by Malden Mills, and Flamestop™, developed by Huntingdon Mills, are fire-resistant, insulating fleece materials made from Nomex®. These are particularly useful garments for helicopter rescue operations in cold weather.
- **Flight helmet:** Although a costly piece of equipment, a helicopter flight helmet provides the most effective head protection in the event of impact. The Gentex Corporation SPH-5 helmet (sound protective helmet) is one of several popular commercial helicopter helmets (Figure 16). It provides a maximum peak force deceleration up to 300 g's (0.4 milliseconds duration) inside the helmet during a sustained impact (using ANSI Z-90.1 test design), which enables the helmet to distribute the impact to a survivable level for the wearer. Testing also involves a penetration test with 1 lb. (0.4536 kg) pointed steel weight dropped from 10 ft. (2.48 m) resulting in less



Figure 16- SPH-5 Flight Helmet. Image copyright Gentex Corporation.

<sup>26</sup> Stern and Stern Industries, Inc.. Nomex® Fabric.

<sup>27</sup> PBI Performance Products.

than ¼ inch penetration.<sup>28</sup> For comparison the European Norm (EN) 12492 and UIAA 106 certification for a climbing helmet involves a penetration test performed with a 6.6 lb. (3.0 kg) weight dropped from 3.2 feet (1.0 m). The flight helmet's design allows communication through a noise-canceling microphone and earphones in the ear cups.

It is important to recognize that military flight helmets and aircraft employ a low impedance design, while civilian flight helmets employ a high impedance design, thereby creating an equipment incompatibility. This design difference can be overcome with an adapter. Other features of a flight helmet include noise suppression, a protective visor, and an energy-absorbing liner. A maxillofacial shield (MFS), which can be attached with latches to a HGU-56/P helmet, protects the lower facial area from flying debris. Even though ground rescuers aboard helicopters on rescue missions frequently wear climbing helmets and firefighter hard hats, a flight helmet is a superior protective device, since it is specifically designed for this application.

- **Footwear and hand, eye, and ear protection:** Fire resistant or leather gloves, as well as leather boots that are at least ankle height, provide added protection against fire injuries. Nylon components on lightweight hiking boots can melt in a post-crash fire, resulting in burn injuries. The environment of the rescue, such as winter alpine conditions or over-water operations, may dictate footwear (e.g., plastic mountaineering boots) that is more reasonable for outside conditions. Fire-resistant clothing should have sleeves that can be worn over the gauntlet of the gloves and legs long enough to eliminate exposure between the clothing and the tops of the boots. Sunglasses or clear safety goggles provide excellent eye protection for the blowing prop wash generated by helicopters. Disposable earplugs provide added hearing protection against the high decibel levels of helicopters.
- **Harnesses:** During hoisting, short-haul, and rappelling operations, mission-specific rescue harnesses are worn by crew chiefs/spotters as a tether to the aircraft. Rescuer/ paramedics/HEMS crewmembers wear harnesses approved by their flight program. The features of these harnesses can include dorsal attachment points, full-body harness design, and suspension comfort.
- **Life vest:** When over-water flights lack sufficient glide distance to shore, the aircrew should don an aviation life vest for personal safety. A manually inflatable (not auto inflate), FAA-approved aviation life vest is required as opposed to a bulky, U.S. Coast Guard-approved, foam-filled personal flotation device (PFD), which would actually restrict a user's ability to safely exit an aircraft submerged in water.

---

<sup>28</sup> Montenegro James, Lead Quality Engineer, Gentex Corp.

## Personal Preparedness

Helicopter rescuers can quickly find themselves deployed into an extreme environment in which they are not adequately prepared to function. They are vulnerable to accidents arising from environmental hazards, such as talus, exposed cliff faces, snow or ice, and swift water. The choice of footwear and outerwear, as well as personal survival gear kept on their person, should be a top priority for aircrew members who could be exposed to such extremes.

## In-Flight Emergency: Survival Plan Checklist

- Follow the instructions of the pilot and aircrew.
- Secure your seat belt and harness.
- Keep clear of the controls, secure all loose gear, and note emergency exits.
- Forward-facing passengers with a shoulder harness should sit in the full upright position with chin tucked downward, with hands on knees and arms pushing them against their seat back.
- Forward-facing passengers without a shoulder harness (lap belt only) should bend forward until their chests rest on their thighs. Arms should be clasped together under their thighs to hold this position.
- Rear-facing passenger should brace with their hands on knees and head against upright portion of their seat back.
- Side-facing passengers should bend forward at the waist, grasp the arms under legs, and place the head between the knees.
- Assist any injured individuals who cannot leave the aircraft.
- Exit the helicopter only after the rotor blades have stopped or when instructed to do so by the aircrew.
- Assess the situation and render aid as needed.

## Emergency Water Ditching Survival Training

Aircrews involved in over-water operations (Figure 17) need to be proficient in emergency water ditching procedures and egress (Box 5). This involves very realistic training with the aid of a “dunker” device as well as breathing devices, which can be brought to a swimming pool, to simulate a water ditching emergency. This training helps participants develop the confidence and muscle memory to survive a water ditching incident without panicking.



**Figure 17- Water Rescue.** An aviation survival technician (AST) jumps from an HH-60 Jayhawk helicopter assigned to Air Station Elizabeth City, NC, during a rescue demonstration. USCG photo by PA2 Jacquelyn Zettles.

### Box 5. **Water Ditching Checklist**

Remind yourself that you can survive a water ditching incident. Most important, **DON'T PANIC!** Panic can be avoided by remaining calm and thinking clearly.

1. Secure loose items. Put your flight helmet visor down and sweep the boom microphone to the side.
2. Unplug your flight helmet.
3. Establish a reference point with your hand (e.g. a door handle). Do not let go of your reference point.
4. Just before contact with the water, crack open the aircraft door.
5. As the aircraft settles in the water, count slowly to five to allow rotor movement to cease.
6. Release your seat belt with your free hand.
7. Know your second exit, if your primary route is blocked.
8. Exit the aircraft, following your reference point hand.
9. Do not kick, since other personnel could be right behind you.
10. Swim out horizontally and then up.
11. Hand up, look up, and come up toward the surface, following the air bubbles.
12. Survey the surface for hazards and survivors.
13. Inflate your flotation device (don't inflate it inside the aircraft).

## Patient Care and Transport Considerations

Providing effective medical care to a packaged rescue subject, while using an external helicopter technique (e.g., hoist or short-haul) is significantly more difficult than in conventional rope-based rescue. Helicopter operations require the litter attendant to contend with rotor wash, flying debris, minimize litter spin, the forward motion of the aircraft, and the subject's medical needs.

During hoisting and short-haul operations, a litter attendant is not in a practical position to perform extensive medical care in-flight. However, the litter attendant is very important in these types of operations. A supine patient who vomits and aspirates in-flight is a potential problem. The eight classic stressors of flight transport, affect a rescue subject including noise, vibration, and thermal changes that occur during helicopter rescue operations (Box 6) (Figure 18). Low-frequency vibration can induce motion sickness, which stimulates the "vomiting center" of the medulla. In addition, vibration can cause fatigue, shortness of breath, and abdominal and chest pain. Vibration against a subject causes mechanical energy to be transformed into heat energy as body tissues

### Box 6. **Eight Classic Stressors of Flight Transport**

1. Noise
2. Vibration
3. Thermal changes
4. Fatigue
5. Barometric pressure
6. Decreased humidity
7. Decreased partial pressure of oxygen
8. Gravity (G) forces



provide dampening, resulting in increased metabolic and respiratory rates. Temperature changes, both hot and cold, in conjunction with exposure to vibration, can inhibit the body's compensation mechanisms.<sup>29</sup>

Visual stimuli and anxiety, compounded by motion, can precipitate the onset of motion sickness, leading to nausea and vomiting. Visual fixation on other moving objects may also precipitate an attack. A recumbent individual can be affected by the visual strobing effect of rotor blades

overhead. It is believed that 5% of the epileptic population suffers from photosensitive epilepsy (aka flicker seizures), which is "triggered by flashing lights or contrasting light and dark patterns."<sup>30</sup> However, "flashing or patterned effects can make people with or without epilepsy feel disorientated, uncomfortable or unwell. This does not necessarily mean they have photosensitive epilepsy."<sup>31</sup> An antiemetic, which controls nausea, vomiting, and motion sickness, may be administered to a patient before a helicopter hoist or short-haul extraction commences.



**Figure 18- Helicopter EMS (HEMS).** Aeromedical crewmembers with Travis County STAR Flight provide in-flight patient care. Image courtesy Travis County STAR Flight, Texas.

If an adequate power margin exists with the helicopter, a litter attendant is beneficial for an injured subject during hoisting and short-haul operations. The presence of an attendant has a considerable positive psychological influence in reducing the injured subject's anxiety level. Prior to transport a patient's airway must be stable or secured with an advanced airway device. Practice and ensure proper attendant positioning in relation to the subject. An inclined, head-up position for the litter, and providing an accompanying attendant to clear the subject's airway manually could make a critical difference. The litter attendant should have a handheld manual suction device readily available on a tether. Unlike other forms of vomiting, vestibular emesis is not relieved by throwing up; therefore, continual suctioning and being prepared to clear the airway several times are vital.

Performing effective cardiopulmonary resuscitation (CPR) in-flight is simply not practical. A subject who is already in cardiac arrest at a rescue scene is best served by good resuscitation efforts there, rather than by attempts at wild heroics in the air. Appropriately realistic and situation based medical protocols are essential in HEMS patient care.

<sup>29</sup> Holleran, René Semonin. *ASTNA Patient Transport: Principles and Practice*, chapter 5.

<sup>30</sup> Epilepsy Society (United Kingdom). *Photosensitive Epilepsy*.

<sup>31</sup> *Ibid.*

The unpressurized helicopter cabin affects care of the subject during changes in elevation because of the principles of common gas laws. Boyle's law states that under conditions of constant temperature and quantity, there is an inverse relationship between the volume and pressure of a gas. As a helicopter climbs to higher altitude, a volume of gas is forced to expand. This can lead to changes in the subject's respiratory rate and depth and in the performance of intravenous lines and also can affect the rigidity of equipment such as the balloon cuffs of endotracheal tubes, vacuum mattresses, and air splints. Elevation changes also can lead to impairment of already injured subjects, including worsening of a pneumothorax or embolism, as well as onset of hypoxia. A subject with a head injury or one who is combative, must be physically and possibly pharmacologically restrained, so that there is no chance the person could make contact with the flight controls or personnel.

## Helicopter Rescue Techniques

### Helicopter Hoist Rescue

#### HISTORY

Helicopter hoist is a widely used and efficient procedure for both insertion and extraction from a rescue site. The first civilian helicopter hoist rescue was performed by Dimitry "Jimmy" Viner, Chief Test Pilot for Sikorsky, near Fairfield, Connecticut, on November 29, 1945. The rescue was initiated to save two men stranded on an oil barge following a violent storm, who were in danger of being washed overboard. An early Sikorsky production model R-5 helicopter pulled off the rescue in Long Island Sound, a short flight distance from the Sikorsky factory (Figure 19).<sup>32</sup>



**Figure 19- First Helicopter Hoist Rescue.** Pilot Dimitry "Jimmy" Viner, using a Sikorsky R-5 Helicopter, performs a hoist rescue at Long Island Sound, on November 29, 1945. Image copyright Sikorsky Aircraft Corporation.

<sup>32</sup> Sikorsky Archives. Rescue Award- First Civilian Helicopter Rescue.

The terms *hoist* and *winch* are often incorrectly used in referring to rescue hoists. For clarification “hoists” are used for lifting and “winches” are used for pulling. (*Note: However the British do refer to a winch for lifting, which includes “helicopter winching.”*)

### OPERATIONAL CONSIDERATIONS

Overall helicopter hoisting shortens the suspended exposure time of the rescuer beneath the helicopter. The fixed installation of a rescue hoist on a helicopter increases operational efficiency, even though the weight of the rescue hoist adds to the overall equipped weight of the helicopter, thus reducing the available payload. Other helicopter rescue techniques can require delays for reconfiguring the aircraft for the mission. The reality of the high cost and maintenance associated with helicopter rescue hoists means that they are primarily available through the military and public safety agencies in larger metropolitan areas.

Helicopter rescue hoists are either electrically powered or hydraulically powered. A hydraulic hoist requires an on-board hydraulic pump system, typically found on larger helicopters. Overall hoist power is limited by the available aircraft power. From the standpoint of power to weight ratio, significant advances in electrical components have lead aircraft manufacturers to increasingly chose electrical (115 volt AC) rescue hoist designs for installations.<sup>33</sup> The installation design for the attachment of rescue hoists

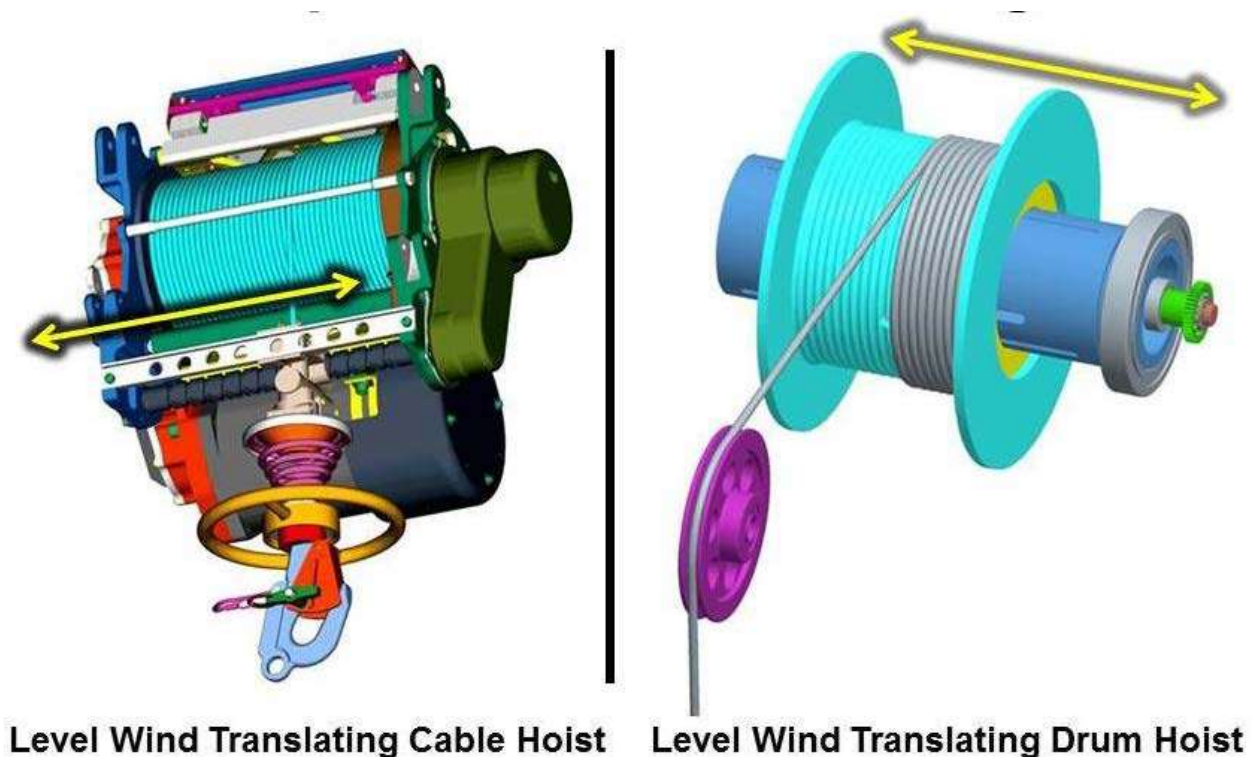

**Figure 20- Helicopter Rescue Hoist Designs.** Level wind translating cable hoist where the drum is stationary and a level wind translating drum hoist that has a moveable drum. Drawings copyright Breeze-Eastern Corporation.

<sup>33</sup> Teel, William. Senior Design Engineer, Goodrich Corporation.

includes both internal and external mounting styles. Internally mounted rescue hoists are configured on a vertical column extending from the floor structure, which mechanically pivots out the aircraft doorway during deployment. An internal hoist configuration can be changed over quickly to other serviceable aircraft, however it consumes useable space within the aircraft interior. Externally mounted hoists can be a fixed installation above the aft doorway or on a moveable boom controlled by the hoist operator, which is stowed against the helicopter fuselage during forward flight.

The two primary rescue hoist designs include the level wind translating cable hoist and a level wind translating drum hoist (Figure 20). The “level-wind” mechanism prevents the line from being trapped under itself on the spool during rewinding. The drum of the translating cable hoist remains stationary, while the level wind moves back and forth spooling or unspooling the cable. The translating drum hoist has a cable drum that moves in front of a stationary level wind during spooling and unspooling operations.

The hoist operator works in the open aft doorway, secured by a safety tether strap, or gunner’s belt, that runs from the operator’s harness to a fixed hard point in the aircraft (Figure 21). The hoist operator uses a handheld pendant hoist control, and most styles provide a visual readout display of the amount of cable in use. The pilot is also equipped with hoist controls on the collective, which can override the hoist operator’s position. Older electric hoists had cycle limits imposed by the manufacturer as low as two hoist uses because of overheating of the motor. Newer hoist technology has led to more efficient motor designs, which permit sufficient hoisting duty cycles to fill the aircraft cabin with subjects during a rescue.<sup>34</sup>



**Figure 21- Hoist operator with boomed hoist.** Positioned on the helicopter skid, with a secure tether to the aircraft, the hoist operator has an unobstructed view of the load. Image courtesy Travis County STAR Flight, Texas.

## Hoist Cable Management

The hoist cable is truly a lifeline and must be treated with respect. Although it is a rare occurrence, a hoist cable can fail. The factors leading to cable failure include corrosion exposure, mistreatment or poor maintenance, operator inexperience or a dynamic shock force that exceeds the static rated load of the cable. A poorly maintained rescue

<sup>34</sup> Teel, William. Senior Design Engineer, Goodrich Corporation.

hoist is a serious concern that threatens operational safety. All hoist cables should be run out from the hoist drum for a visual and tactile inspection after every hoist mission.

### Hoist Cable Construction

Helicopter hoist cables are most commonly 3/16 inch (5 cm) in diameter with a mean breaking strength (MBS) of 3,330 lbs. (1510 kg) and rated working load capacity on the hoist of 600 lbs. (272 kg). Lighter helicopter hoists are produced with a rated working capacity of either 450 lbs. (204 kg) or 300 lbs. (136 kg), which employ 5/32 inch (3.9mm) cable with a 2,160 (979.7kg) MBS.<sup>35</sup> The construction of the cable allows for some degree of shock absorbance over the length of the cable. The cable is most vulnerable to a shock force when there is only a few feet of cable spooled out. The stainless steel hoist cable (wire rope) has a spin-resistant feature, which is accomplished through the counter-wrapping of the wire strands. A free-spinning hook at the end of the cable also serves as a swivel between the load and the hoist cable, preventing twisting of the cable. Hoist cable lengths vary considerably, but 245 feet (75 m) of usable cable is a common working length for many rescue helicopters. The initial 20 feet (6m) and final 20 feet (6m) of cable may be marked with a high visibility color to provide a visual warning indicator to the hoist operator of an approaching end.<sup>36</sup>

The typical 3/16 inch (5 cm) diameter military spec rescue hoist cable is manufactured with austenitic (non-heat treated) stainless steel wires configured in a nineteen by seven strand “non-rotating” construction design, meaning nineteen strands of seven wires each. It is manufactured by covering an inner wire rope of 7 X 7 left lay construction with 12 strands in a right regular lay configuration, which creates a cable constructed of 133 individual wires (Figure 22). The spin-resistant property that characterizes this construction is a result of the counter torques developed by the two layers.<sup>37</sup> This arrangement prevents the cable from unwinding while a load is suspended during use. Although the military specification refers to this as a non-rotating wire rope, it is more accurately a rotation resistant wire rope, and will in fact rotate under load.<sup>38</sup>

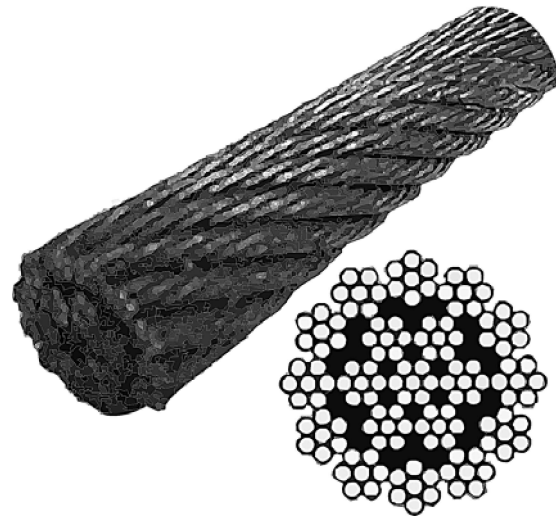

**Figure 22- Wire Rope Cross-section.**  
Constructed of seven inner bundles with a left lay, surrounded by 12 counter wrapped bundles with a right regular lay.

<sup>35</sup> Doyle, Patrick. Engineer. Breeze-Eastern Corporation.

<sup>36</sup> Dept. of Defense. Concept Evaluation of UH-60 Externally Mounted Rescue Hoist. Section 1.4.1

<sup>37</sup> Dept. of Defense. Wire Rope Specification.

<sup>38</sup> Mitchell, Michael. President. Zephyr International LLC.

## Hoist Cable and Rescue Hook Assembly

Helicopter hoist rescue utilizes a hoist cable attached to a rescue hook assembly. There are several upgraded hook assembly designs, however the traditional military style is based upon an older 1963 design, which consists of two gated hooks and an eyelet (Figure 23). The large hook is the only portion of the rescue hook to be used for hoisting personnel. The smaller hook is utilized for handling equipment or light cargo. The smaller equipment hook on the opposite side of the rescue hook is not intended to be used to hoist personnel. This equipment hook also provides a possible point for entanglement, and must be managed appropriately. The equipment ring is an additional attachment point intended for cargo hoisting, and may be used to suspend chemical lightsticks during night operations. The upper section of the hook assembly is a ball bearing swivel, crush bumper assembly, and cable stop.

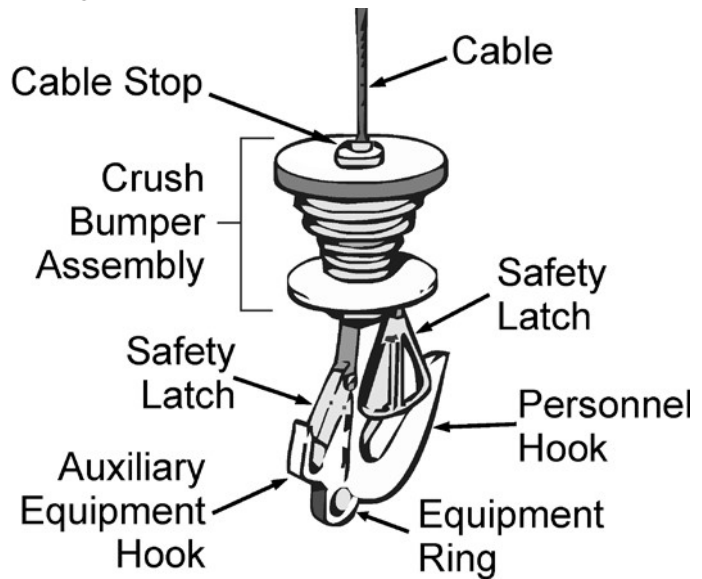

**Figure 23- Helicopter rescue hook.** Traditional hoist hook conforming to military spec design 18027-2A.

### UNINTENTIONAL DISENGAGEMENT (Rollout)

The inadvertent release of a load or “rollout” from a hoist hook can occur when a carabiner or attachment D-ring travels upward, through possible load relief, and rides up against the safety latch of the hoist hook. This reversal up over the point of the hook puts pressure on a non-locking safety latch, which can self-release the load. A fatal accident occurred in December 1995, when a rescue strop separated from the hoist hook of an Australian Navy S-70B-2 helicopter. The hoist hook was relieved of the weight of the load, when it touched the ground before being hoisted up, thereby permitting the connection point to become dangerously oriented across the non-locking gate of the hoist hook.<sup>39</sup> This dangerous phenomenon can be prevented through the use of attachment rings, which do not permit reversing over the point of the hook, and the use of auto-locking hoist hooks. All personnel involved in hoist rescue operations, particularly ground rescuers, should be well-briefed on the phenomenon of rollout and how to prevent it. This includes the use of compatibly sized connectors and the practice of physically maintaining proper orientation of all connectors at the hoist hook during lifting.

<sup>39</sup> Australia Civil Aviation Safety Authority, AAC 1-103

## AUTO-LOCKING HOIST HOOKS

A hoist hook with an auto-locking gate (Figure 24) provides the greatest amount of security against inadvertent rollout as well as accidental opening leading to entanglement of equipment or lines at a rescue scene. The auto-locking feature provides a latch, which is always locked for maximum safety, and requires a positive action that must be overcome by a rescuer.

### Possible Cable Damage

Visual inspection of a hoist cable is conducted following a mission by running out the full operating length of the cable on the ground. The cable is retracted under a tensioned load to prevent cable fouling on the drum. Helicopter hoists have a tensioning system, which maintains approximately 7 to 20 lbs. (3.1-9 kg) of force on the cable, in order to prevent loosening of the wraps on the drum, however this can be defeated during an inspection so a mechanically applied load may be required. Hoist cable damage can include a single broken wire strand as well as multiple broken strands within a section of cable, requiring replacement of the cable. Additional problems may include;



**Figure 24- Auto-locking hook.** The Aerial Auto-Lok Hook provides a secure gate reducing the likelihood of rollout or entanglement. Image copyright Aerial Machine and Tool.

### KINK

A loop in the cable may lead to developing a kink, which may be identified as open or closed. An open kink is caused by pulling a cable loop tight, creating a permanent bend which tends to open the lay of the cable. A closed kink is created in the same manner, but creates a sharp permanent bend that tends to close the lay of the cable. A kink in a cable significantly reduces the load capacity. The continued use of a kinked cable can lead to the kink being caught in the cable guide assembly resulting in cable fouling. Hoist operations should be terminated when a kinked cable develops.

### ABRASION

A cable may develop abrasion if it contacts other material, such as aircraft structural members. Dirt, sand, grit, and other foreign particles can also result in abrasion. Abrasion weakens the cable by removing metal from the wires in the outer strands. Cables that show signs of excessive abrasion should be removed from service.

### BIRDCAGING

A deformity with a distinctive “birdcage” appearance may develop where a hoist cable has significant stretched open or untwisted outer wraps of wire strands in an uneven or irregular bulging manner. Minor uniform opening of strands, which can be corrected, is not considered birdcaging. Severe birdcaging will result in a small bubble being formed by the outer strands. Birdcaging results from torsional imbalance that occurs because of mistreatments, such as sudden stops, cable being worked through tight sheaves, or a hook bearing that is not rotating freely. A hoist evolution should be terminated if there is the presence of birdcaging on a cable.

## OVERLOAD

A cable that has been severely overloaded may or may not show immediate results of the overload. Visual broken wires are the most obvious defect, however, overloading can cause broken core wires that are not readily visible. Necking-down is a noticeable reduction of cable diameter indicating broken internal core wires. Any cable with necking-down is cause for immediate replacement. Any cable that is known to have been overloaded must be replaced prior to continued hoist operations. In such situations, the hoist operation should be terminated and excess cable reeled in if defects do not cause cable fouling.

## DEFECTIVE BALL FITTING

An improperly stored hook will cause the hook to swing in flight damaging the cable. The terminus of the cable inside the hook has a swaged ball fitting, where broken wires may develop. This can be prevented by properly seating the hoist cable bumper against the cable guide bell mouth, when the hoist is not in use.

## Static Discharge

Helicopters generate static electricity as air particles move over the surface of the fuselage and rotor blades.<sup>40</sup> A larger helicopter in drier air generates significantly more static electricity because a greater surface area is interacting with air particles and an increased air mass is moving over the fuselage. Composite fuselages increase the potential for static charge buildup. Blowing snow or dust also increases the interaction with the aircraft and the risk of static discharge. Forward flight causes some of the static to bleed off the tail of the aircraft. However, in a hover, the static does not bleed off. The practice of keying the radio microphone on board the aircraft to discharge the static has only a limited effect, because it relieves only the static in the immediate vicinity of the antennas.<sup>41</sup>

If static is present, the hoist cable becomes grounded when touched by ground personnel, who may receive a harmful shock as the static electricity is discharged.

**Rescuers can prevent this static shock by always allowing the hoist cable to contact the ground before they touch it.** However, it is important to remember that a static charge rebuilds quickly (in a matter of seconds) once the helicopter is no longer grounded.<sup>42</sup> A static discharge cable, which is ten feet long, may be suspended from a hoist hook to discharge static electricity prior to the hook actually making contact with the surface (Figure 25).



**Figure 25- Static discharge cable.** Image copyright Aerial Machine and Tool Corp.

<sup>40</sup> Croucher, Phil. Helicopter Pilot's Handbook, page 71.

<sup>41</sup> Martin, Adam. Aeronautical Engineer, Sikorsky Aircraft Corp.

<sup>42</sup> Ibid.



## Line Entanglement

The hazard of line entanglement has been described previously. During a helicopter hoist rescue operations this is a very real concern as the cable reaches the ground or structures. During hoist or short-haul rescues, a line or hook has become entangled with rescuer packs, ices axes, harness gear loops, non-locking carabiners, and more. These incidents have included fatal outcomes.

**NOTE: All rescue personnel should be well-briefed regarding the danger of line entanglement during helicopter hoist and short-haul operations.**

Conscious efforts should be made to prevent entanglement of the hoist cable, or the load on the line, with fixed objects on the ground. This is accomplished through proactive planning and engineering an entanglement-free environment. The hoist operator should maintain a visual reference with the hoist hook at all times. The extraction phase of a short-haul should be treated as a critical phase of flight, with increased vigilance and mental preparation toward reacting to a problem.

When hoist rescue work must be performed within close proximity to high voltage power lines, the potential exists for electricity to energize the hoist cable and injure personnel on the ground. An energized high voltage power line generates electric and magnetic fields (EMF). EMF is comprised of waves of electric and magnetic energy moving together (radiating) through space. The EPA warns, “A person standing directly under a high-voltage transmission line may feel a mild shock when touching something that conducts electricity”.<sup>43</sup>

### CABLE CUTTER

If the cable becomes hopelessly entangled or during an aircraft emergency, the hoist operator can activate an emergency cable cutter (Figure 26), which is an electrically activated squib charge that propels a chisel-end cutter, severing the cable at the bell mouth, where the cable exits the hoist. The cable cutter can also be activated through the pilot’s controls. A helicopter hoist operator needs to have a secondary means of cutting



**Figure 26- Cable cutter control.** Red guarded switch on hoist pennant control. Image courtesy Travis County STAR Flight, Texas.



**Figure 27- AxelCut Cable Cutter.** Image copyright Zephyr International.

<sup>43</sup> EPA. Electric and Magnetic Fields (EMF) Radiation from Power Lines.

the cable in the event of a squib failure. Emergency cable cutters are mounted adjacent to the hoist operator's station. A standard cutting device is the Zephyr International AxleCut Cable Cutter. The two-pound device provides a lightweight (2 lbs.) one-handed cable cutting tool that does not rely on an explosive charge and is extremely effective (Figure 27).

### CABLE SPLICE

To become operational again, once a cable has been sheered manually (not with use of the hoist-mounted ballistic cutter), it is possible to utilize a cable splice with a spare hoist hook as a backup device (Figure 28). This permits in-flight replacement of the hoist hook for the purpose of retrieving personnel when no backup hoist or aircraft is available. The hoist cable is laced through preconfigured notches on the cable splice plate providing a secure friction connection. Use of the cable splice will defeat the safety features of the stop limit switches of the rescue hoist.



**Figure 28- Cable Splice.** Image copyright Aerial Machine and Tool.

### BELAY LINE

The U.S. Navy is one of the only agencies requiring use of a separate belay line in conjunction with rescue hoist operations. Their procedures read; *“A belay shall be used in conjunction with all live practice hoist training evolutions above 10 feet AGL (3m). When hoisting personnel during actual rescue operations, use of the belay system is highly recommended. Failure of the rescue hoist system without the safety of a belay system overland may result in serious injury or death to personnel on the hoist.”*<sup>44</sup>

Note: Navy procedures mandate the use of a belay plate device, however it is important to note that such commercial devices are only designed to safely manage the force associated with a single person load.

### FLEET ANGLES

The lateral center-of-gravity (CG) limits on the helicopter establish the maximum load rating for the hoist, if less than the manufacturer's stated hoist capacity. As excessive loads are placed out away from an imaginary line drawn down through the rotor mast, the helicopter becomes out of balance.

Additionally limitations may be imposed upon the angle a load is out of alignment from the hoist itself. This angle, formed between the loaded cable and an imaginary line drawn perpendicular to the axis of the drum, is referred to as “fleet angle.” High fleet angles (greater than 30 degrees) can be generated spontaneously from pitching vessel decks, swift water operations, high winds, obstacles, terrain or factors beyond the control of the flight crew. Since high fleet angles could potentially exceed the operating

<sup>44</sup> U.S. Navy SAR Manual 3-50.1, sec. 4.4.4

capabilities of a rescue hoist, it important to have an operating knowledge of the manufacturer specifications.

#### TAG LINE (Trail Line)

A tag line (trail line) may be employed by personnel on the ground or a vessel to assist with hoist hook delivery, however use of such a line to stabilize a litter during a hoisting evolution is very important. The rescue litter on the end of a hoist cable can quickly develop an uncontrollable spin in certain configurations. The use of a handheld tended tag line between an attendant on the ground and the litter can eliminate rotational spinning (Figure 29). The configuration can be a single point to the foot end of the litter or a Y-configuration that secures to both the foot and head ends of the litter. The connection point at the litter includes a quick-release to permit the hoist operator to detach the line, once the litter reaches the aircraft doorway. Finally, a breakaway link is configured in-line between the release mechanism and the tag line itself. This link can be constructed from a loop of much thinner cordage, with a low breaking strength, or lightweight cable ties. In the event the helicopter makes an emergency maneuver during a hoisting, the tag line connection is designed to fail from the additional applied force.



**Figure 29- Hoisting with tag line.** Los Angeles City Fire Department personnel aboard a twin engine AugustaWestland AW139 prepare to receive a Bauman Bag equipped with a tagline, which is controlled from the ground. Image courtesy of Los Angeles City Fire Department.

The standard U.S. Navy tag line is constructed with 120 ft. (36m) of 3/8" (9.5mm) polyethylene or polypropylene line and is configured with a weak-link connection that will break with apx. 450 lbs. (204 kg) of force.<sup>45</sup> It can be deployed from the aircraft hand-over-hand with a 5 lb. (2.2 kg) weight bag attached. The tag line connection is made directly to the foot end of a litter or connected into a pre-rigged v-strap, which attaches to both the foot and head end of a Medevac or Stokes-type litter for hoisting. Ground rescuers should be wearing gloves when handling a tag line during hoisting and the line is not to be anchored directly to the ground (Figure 30). Tag lines are nonconductive and will not ground the litter, so the litter should be permitted to make contact with the ground in order to safely dissipate static electricity.



**Figure 30- Preparing to hoist with tagline.** U.S. Park Police Bell 412 “Eagle One” crew conducts a rescue on Old Rag Mountain with NPS SAR personnel at Shenandoah National Park. NPS Photo by Hazel Mehne.

#### STATIC HOIST TECHNIQUE

Use of a tagline is a standard procedure for a military helicopter “static hoist” evolution, where the aircraft remains stationary in a hover above the rescue scene.

Be alert when working beneath heavy-lift (Type 1) helicopters during hoist rescue operations, because the increased rotor wash can easily cause debris from slopes or forest canopy to strike ground rescuers, as well as cause them to lose footing.

#### DYNAMIC HOIST TECHNIQUE

Another helicopter hoisting method is referred to as a “dynamic hoist.” This technique involves lowering a rescuer on the hoist, while the helicopter is on final approach to the scene. The rescuer reaches the ground just as the aircraft is directly above the scene, and the rescuer immediately detaches, permitting the aircraft to depart. When the rescuer is ready for extraction with the patient, the helicopter returns, and following connection to the hoist cable, hoisting of the load is initiated with the aircraft

<sup>45</sup> U.S. Navy SAR Manual 3-50.1, sec. 5.4.1.7

immediately transitioning into forward flight away from the scene. A tag line is not utilized. This technique has the advantage of significantly reducing hover time over the rescue site. In order to reduce the potential for litter spinning during the hoist, the patient must be packaged in a helicopter rescue bag (e.g. Bauman Bag) as opposed to an open basket stretcher (e.g. Stokes). Forward flight does tend to dampen

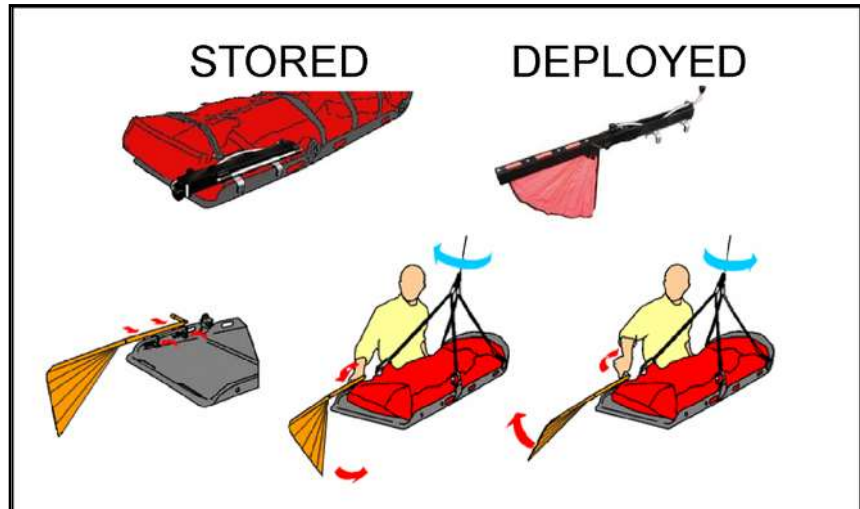

**Figure 31- Anti-Rotation Stabilizer for helicopter hoisting attached to Franco Garda Stretcher.** Images copyright TSL Rescue, France.

out rotational spinning, which can sometimes be minimized by the rescuer attendant sticking an arm out. Attaching a tail on a rescue litter to dampen spinning in forward flight has included the use of a small windsock or drogue parachute, however there is the potential for such a device to become an entanglement hazard while on the ground. French manufacturer TSL Rescue working in conjunction with helicopter rescue personnel has developed a foldable “anti-rotation stabilizer” which is designed to be attached to their lightweight composite rigid stretcher (Figure 31).<sup>46</sup> The majority of European helicopter rescue operations successfully employ dynamic hoisting in conjunction with medium-sized (Type II) helicopters (e.g. AS350 B3, EC-145, etc.), throughout the Alps. This technique is also employed successfully by some civilian agencies within the United States.

## HOIST OPERATOR PROCEDURES

A hoist operator monitors the cable reeling on the hoist drum for proper wrapping or unwrapping and ensures the hoist cable does not contact any portion of the helicopter. Helicopter skid tubes have a cable skid guard installed to prevent abrasion damage by contact from the hoist cable. The hoist operator must be cautious not to place fingers in or around the hoist assembly or hoist cable bumper due to the potential for a crush injury to fingers during hoisting operations. During an extraction with an external fixed mounted hoist, a rescuer should be briefed to maintain visual awareness as they approach the skid tube. They need to avoid striking the skid tube with their head and guide themselves around the skid as they are lifted up to the aircraft.

Hoist evolutions are conducted by the hoist operator maintaining control of the load through the use of hoist controls, coordinated movement of the aircraft with the pilot, and physical control of the cable with a leather gloved hand. The cable slack needs to be kept to a minimum and all crewmembers must be vigilant to prevent situations that would produce shock forces on the cable. A shock force or overloading the cable can cause broken core wires that are not readily visible. Necking-down is a noticeable

<sup>46</sup> TSL Rescue. Product catalogue, page 11.

reduction of cable diameter indicating broken internal core wires. If a cable receives a significant shock force, the hoist operation needs to be terminated. Also, moderate surface winds can aid the hoist operation, since they increase the hovering capability of helicopter.

### Litter Transfer in Exposed Terrain

During a rescue operation where the stretcher is positioned in hazardously exposed terrain, it needs to be tethered with a dedicated safety line rigged cleanly to an anchor system, until the helicopter extraction is actually occurring. The transfer to the hoist cable needs to occur in a well-coordinated and accurately briefed maneuver. When the hoist hook is delivered to the ground rescuers, a designated team member should physically take control of it and position it within a few inches of the stretcher connection point. When directed, a quick transfer of the stretcher connection point will be made from the safety line to the hoist hook. During this time the stretcher will be momentarily disconnected from the safety line, however the aircraft will not become tethered directly to the ground. There are more advanced belaying techniques for managing a completely suspended litter during the initial phase of a hoist extraction, which allow for a smooth transfer of weight to hoist cable. These techniques are beyond the scope of this text. Relocating the stretcher on to a shelf or outcropping, where the full weight is support is supported by the rock rather than a rope system is a preferred procedure.

The exposed downhill side of the stretcher should be considered off-limits and kept free of personnel or rigging. During a hoist extraction, a rescuer stepping to the downhill side of the litter, especially when secured by a safety tether, places them in jeopardy and creates the potential for entanglement to occur.

### Helicopter Rappel

#### HISTORY

Early use of the helicopter rappel included military operations in combat. The 11th Air Assault Division (U.S. Army) introduced the earliest combat use of helicopter rappelling in combination with troop ladders in 1964-1965. This was conducted in combat in December, 1965, near An Khe in Vietnam by the 1st Airborne Brigade of the 1st Cavalry Division (Airmobile).<sup>47</sup> Helicopter rappelling, also known as



**Figure 32- Heli-rappel insertion.** Yosemite National Park SAR (YOSAR) heli-rappeller descends from Bell 205A-1 helicopter (Helicopter 551). NPS photo by Dave Pope.

<sup>47</sup> Mertel, Kenneth. Airmobile-style rappel and troop ladder, US Army Aviation Digest.

heli-rappelling, has also been used in law enforcement tactical operations and wildland fire suppression. It was first tested for wildland fire suppression in 1964 at Shasta Lake in Northern California.<sup>48</sup>

### OPERATIONAL CONSIDERATIONS

Rescuer insertion can be accomplished via helicopter rappelling (Figure 32), which offers reduced exposure time of the rescuer beneath the aircraft compared with a helicopter short-haul. Helicopter rappelling has inherent hazards and mishaps have occurred involving loss of descent control, with subjects striking the ground; a jammed descender caused by entanglement with clothing or hair; a rappel rope that does not reach the ground; and rappeller injury caused by striking the door threshold or skid when exiting the helicopter.



**Figure 33- Sky Genie Descender.** Image copyright Descent Control Inc.

The U.S. Navy currently employs the Sky Genie descender device (Figure 33) and related lines in rappel operations with a separate attended belay line. Following a fatal rappel accident on July 21, 2009, the U.S. Forest Service critically reviewed their heli-rappel program for wildland fire operations and use of the Sky Genie device. A critical factor in the associated accident was “inattentive blindness” as the rappeller had an improperly configured connection point to his harness, resulting in an unrestrained fall to the ground as they prepared to depart from the aircraft.<sup>49</sup>



**Figure 34- Heli-rappel.** Yosemite National Park SAR personnel conduct heli-rappel training from a Bell 205A-1 helicopter using a Petzl RIG descender. NPS photo by Peter McDermott.

<sup>48</sup> U.S. Forest Service, Helicopter Rappel Guide. 1990, p. 2

<sup>49</sup> U.S. Forest Service, Aircraft Accident Investigation Report, July 21, 2009.

An overhead rappel anchor point, which must be FAA approved through a supplemental type certificate (STC) as an aircraft modification, provides the most convenient departure for the rappeller from the aircraft (Figure 34). The length of a helicopter rappel varies by agency preference and by environmental considerations, which may include insertion into tall forest canopy. Rappels of 75 to 150 ft. (23 to 46 m) are most common. Although longer rappels are possible, increased distance extends the required hover time of the helicopter.

A helicopter rappel mission commonly involves a mission briefing, preflight inspection of equipment, and a rappeller safety check of personal equipment. Upon arrival at a rescue site, a reconnaissance flight is completed. The pilot then establishes hover above the insertion site, the rappel rope is deployed and the spotter signals the rescuer to move from his or her seat to the exit position with the descender connected to the rappel line.

Procedures for exiting the aircraft vary based on the make of the aircraft and its configuration. Descents are typically made outside the helicopter skid, however on smaller aircraft agencies have employed a technique of rappelling inside the skid to maintain the CG of the helicopter. The size and allowable payload of the helicopter can permit rappellers to depart from both sides of the aircraft simultaneously. Egress from the aircraft should be coordinated by the on board spotter to be as smooth as possible. As a rappeller initiates the descent on the outside of a helicopter skid, his or her weight is transferred laterally away from the aircraft's CG. This has the potential to exceed the safe operating requirements of the helicopter.

From the vantage point of the spotter and pilot above, it is difficult to determine the height of the rappeller from the ground. Depending on the ambient lighting, the horizontal offset distance of the shadow of the load, from the load itself, provides a good reference as to for the rappeller's height. As the rappeller descends, the shadow offset decreases until the shadow joins the load just as it contacts the ground.

## Helicopter Short-haul

A helicopter short-haul rescue permits the insertion of personnel, suspended beneath a hovering helicopter on a fixed line, as well as the extraction of a subject or rescuers from a site where a helicopter cannot land.

### HISTORY

As early as November 1952, the so-called "helicopter lift" technique was utilized by Swiss Air Rescue, which later became known as REGA (Figure 35). Swiss Air-Rescue REGA, founded in



**Figure 35- "Helicopter Lift Technique."**

This early predecessor to the current helicopter short-haul technique was developed in 1952 by REGA. Image copyright REGA.



1952, is a non-profit foundation, which is a corporate member of the Swiss Red Cross. REGA is derived from the German word Rettungsflugwacht (meaning air rescue service), and its French name, Garde Aérienne (meaning air guard). The helicopter lift technique involved a large hot-air balloon basket suspended directly beneath an early model Hiller helicopter, carrying a rescuer. Although military extraction techniques (Box 7) were being developed simultaneously, Swiss Air Rescue introduced the “knotted rope technique” in 1966 for use in mountain rescue.<sup>50</sup> This predecessor to helicopter short-haul involved a line knotted at intervals that a rescuer would climb down and then sit on a plastic disc seat at the end of the line beneath the helicopter. Parks Canada incorporated the first civilian North American use of short-haul as the helicopter sling rescue system (HSRS), with a rescue deployment in July 1972 on Mount Edith in Banff National Park.<sup>51</sup>

### BOX 7. MILITARY EXTRACTION TECHNIQUES

Military combat helicopter extraction techniques, such as McGuire and STABO Rigs, were developed during the Vietnam War (1959-1975). Discrepancy exists on whether the STABO name was contrived from STABILized BOdy harness, the inventor names of Stevens, Knabb, and Roberts, or finally simply Stabilized Tactical Airborne Body Operations. These techniques, as well as the Palmer Rig or the Jungle Operations Extraction System (JOES), which served U.S. Special Forces troops during the 1960s, have been refined and now are known as the fast rope insertion/extraction system (FRIES).

Originally, an insertion or extraction system was referred to as a special procedure insertion and extraction system (SPIES), but the U.S. Army has combined the two methods into one term. FRIES now includes insertion of troops by means of fast roping (sliding down a large braided rope to the ground) and then extraction on a single, fixed rope lowered from the helicopter. Several soldiers, wearing special harnesses, attach themselves by means of rings woven into the rope at 5-foot (1.5m) intervals on the line (Figure 36). The soldiers are lifted en mass away from the extraction site by helicopter.

Source: Pushies, Fred. U.S. Army Special Forces, p. 109



**Figure 36- SPIES Training.** U.S. Navy explosive ordnance disposal technicians participate in SPIES training from an MH-60S Knighthawk helicopter. US Navy photo by Mass Communication Spec. 2nd Class Kenneth Abbate.

<sup>50</sup> REGA (Swiss Air-Rescue), About Us- History.

<sup>51</sup> Marty, Sid. Men for the Mountains, p. 198-201.

## OPERATIONAL CONSIDERATIONS

A helicopter short-haul is not a procedure that should ever be improvised on the spot. Ample training of both pilot and rescue technicians is mandatory for safe operations. Helicopter short-haul requires pilot proficiency in vertical reference flight operations (Figure 36). Rescuer proficiency is easier to maintain with the short-haul technique than with helicopter rappelling, since short-haul technique requires fewer rescuer manipulations.

The exposure time of the short-haul rescuer during forward flight is greater than during a helicopter rappel. To minimize this exposure time, short-haul flights should be limited to the shortest possible flight distance practical. The name “short-haul” is derived from this distance factor, rather than from the length of line used. A major advantage of helicopter short-haul is that hover time can be shorter than with heli-rappelling or “static” hoist rescue. Additionally short-haul operations are not restricted to the standard lengths of helicopter hoist cables and higher load limits than hoist operations may be employed, since the short-haul load is suspended directly beneath the aircraft without lateral CG limits being a factor. Short-haul operations do require proximity to a landing zone to permit configuring the aircraft for the mission and transfer of the patient to a HEMS aircraft or internal transport by a rescue aircraft.

A single line configuration for a short-haul line is common with most rescue organizations. Multiple line configurations have been employed for redundancy but tend to be cumbersome, because of the risk associated with individual lines becoming entangled when they become slack. A pre-rigged short-haul line with a solid metal ring or rope thimble at the terminus of the line provides rescue personnel with a point for easy attachment during a hook-up sequence. The line length varies between agencies, however 100-200 foot (30-60m) lengths are most common. Shorter lengths expose



**Figure 37- Short-haul rescue.** Grand Canyon National Park SAR personnel conduct a short-haul rescue of an injured subject at Mather Point with an NPS MD-900 Helicopter. NPS photo.

ground rescuers to excessive rotor wash and the aircraft must descend closer to ground hazards. Longer lengths create a vertical reference challenge for the pilot to control the load.

The use of spring-loaded, auto-locking carabiners for all connection points, both at the aircraft and on the end of the line, provides a positive means to prevent in-flight vibration from accidentally unlocking a carabiner. It is critical that the short-haul line be attached to an anchor “system” on the aircraft, which incorporates both a primary anchor point and secondary anchor point to prevent accidental release (Figure 37). This redundancy in the short-haul anchor is designed to prevent a catastrophic loss of the short-haul load and HEC. The primary and backup anchor must be designed for release in an emergency by the spotter or pilot, utilizing two separate and specific actions. As with high-angle rope rescue systems, the static system safety factor (SSSF) must be evaluated for the entire short-haul system from the anchor to the rescuer harness. The SSSF is the ratio between the maximum expected static force that is expected to be applied to the breaking strength of the weakest link in the system (450 lb. [204 kg] load minimum). The FAA requires a SSSF of 3.5:1 for external load attaching components as well as the associated personnel carrying device system for helicopter HEC applications.<sup>52</sup> The DOI applies a 10:1 SSSF stating that, “...reliance on a single component at any point in the system should be avoided. Where single points exist, annual testing and documentation should occur to ensure component reliability.”<sup>53</sup>



**Figure 38- Anchor system.** Short-haul anchor system, with releasable cargo hook serving as primary anchor point and yoke band (red) with three-ring release providing secondary anchor point. NPS photo.

Rescue harness selection for short-haul operations should evaluate how the rescuer will fly when encumbered with a loaded pack. The best option is a configuration that does not require the rescuer to grasp the line to maintain an upright orientation. This can be accomplished by using a full-body harness with a sternal attachment point, which raises the CG of the wear. Another option is to utilize a seat and chest harness combination in conjunction with preconfigured tether straps (e.g. daisy chains girth hitched to the seat harness and passed through the chest harness) that can quickly be attached to the short-haul line.

Single-point rescuer attachment techniques are a standard for agencies involved in for hoist or short-haul operations, but the key is that these must be configured with

<sup>52</sup> U.S. Govt. 14 CFR. Part 27.865. External Loads.

<sup>53</sup> DOI Helicopter Short-Haul Handbook. 2010 ed., page 7.

appropriate components to eliminate human-error or failure of this critical connection point. A commercially produced tether strap used in conjunction with an auto-locking carabiner is an example of such an application. To create redundancy, some agencies, such as the National Park Service, do employ two separate rescuer attachment straps for connection to a line during short-haul operations.

The composition of the short-haul line needs to be a material that provides a high strength-to-weight ratio. Line selection may include nylon or Dyneema®, the latter of which is ultra-high-molecular-weight polyethylene (UHMWPE). The diameter of the line will be based upon the breaking strength of the material to achieve the 10:1 SSSF. The short-haul line is rigged with a weight close to the lower terminus, which prevents an unloaded line from trailing too far behind the aircraft during forward flight and getting close to the tail rotor. This can be a 12-20 lbs. (5.4-9 kg) weight bag, which is attached to the line.

### Short-haul Operational Hazards

The danger of line entanglement exists, because the short-haul line can quickly become snarled in vegetation or ground obstructions. The short-haul anchor point in the helicopter needs to be releasable in the event of line entanglement, which can't be cleared from the ground. During extraction operations, all rescuers must be clear of potential entanglement hazards (Figure 39). Use mental projection to ask, "What could go wrong, and how can we avoid it?" Also, remember that a low-hovering helicopter is operating within the "dead man's curve," which hinders the pilot's ability to execute an autorotation safely (Figure 40). This condition applies to hoist operations and heli-rappel as well. A very serious problem is the rotational spinning of a loaded litter during a short-haul evolution. Several factors can affect in-flight litter spinning, including the manner in which the litter is rigged (off center rigging aggravates a spin), an attendant off balance when lifted off the ground, rotor wash, and lack of forward airspeed.



**Figure 39- Critical phase of flight.** All rescue personnel should be aware of the potential for entanglement during an extraction. YOSAR personnel at Yosemite National Park conduct a short-haul rescue from Royal Arches. NPS photo.

Although some rescue organizations use a Stokes-style litter for short-haul rescue operations, a helicopter rescue bag (heli-rescue bag), such as a Bauman Bag provides a much more aerodynamic patient transport device. These were designed specifically

Helicopter Height-Velocity Chart

**Figure 40 Height-Velocity Diagram.** During a hover, short-haul operations are conducted from a height of less than 200 feet with zero forward airspeed, which places the aircraft and personnel within the “dead man’s curve.” Photo illustration by Ken Phillips.

Short-Haul Operations Are Routinely Conducted Within The “Dead Man’s Curve” Of The Height-Velocity Chart

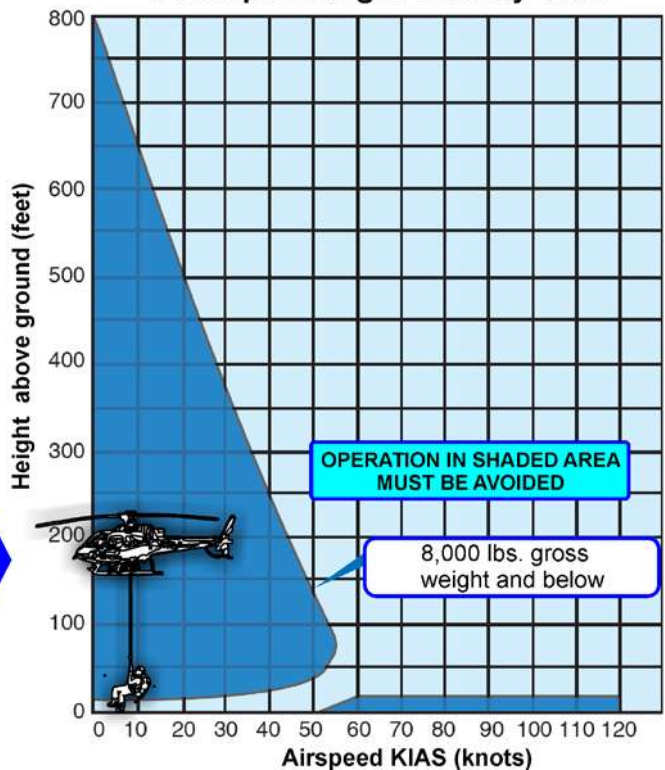

as aerial patient transport devices and have proven themselves to be more aerodynamic than a rigid basket stretcher.

**Litter Transfer in Exposed Terrain** (similar to hoist procedures)

Short-haul rescue operations in exposed technical terrain add a higher level of complexity (Figure 41). When the stretcher is positioned in hazardously exposed terrain, it needs to be tethered with a dedicated cleanly rigged safety line to an anchor system, until the helicopter extraction is actually occurring. The transfer to the short-haul line needs to occur in a well-coordinated and accurately briefed maneuver. When the terminus of the short-haul line is delivered to the ground rescuers, a designated team member should physically take control of it and position it within a few inches of the Bauman Bag connection point. When directed, a quick transfer of the Bauman



**Figure 41- YOSAR El Capitan short-haul rescue.** Two Yosemite National Park rescuers prepare to be inserted in exposed technical terrain on El Capitan. NPS photo by Dov Bock.

Bag connection point is made from the safety line to the short-haul line. During this time the Bauman Bag will be momentarily disconnected from the safety line, however the aircraft will not become tethered directly to the ground. There are more advanced belaying techniques for managing a completely suspended litter during the initial phase of a hoist extraction, which allow for a smooth transfer of weight to the short-haul line. These techniques are beyond the scope of this text. The preferable scenario is to relocate the stretcher on to a shelf or outcropping, where the full weight is supported by the rock rather than a rope system.

Additionally, during an extraction, the exposed downhill side of the stretcher should be kept free of personnel and rigging and considered off-limits. Stepping to the downhill side of the litter during an extraction places a rescuer in jeopardy and creates the potential for entanglement to occur.

### **Short-haul Emergency Procedures**

In the event of an in-flight emergency, jettisoning a human load from beneath a helicopter is not a realistic strategy. A crash event occurs unbelievably quickly, and the reaction time of the spotter would likely be inadequate. Survival of short-haul personnel during an in-flight emergency is best accomplished by having suspended personnel remain attached to the rope while the pilot attempts an emergency landing. Rescuers should train in advance using the parachute landing fall (PLF) technique as a means of dissipating the energy of a hard impact. During a mission briefing, it is important that this danger be discussed openly, as well as the planned actions of all team members. It is imperative that everyone involved in short-haul understand how instantaneously an in-flight emergency may occur.

Important considerations for helicopter short-haul operations include:

- An improvised helicopter short-haul during a rescue operation is dangerous. Accidents and near-misses have occurred when agencies attempted to improvise a short-haul rescue without pre-planning or prior training.
- Helicopter short-haul requires pilot proficiency in vertical reference and precision placement flight operations.
- The exposure time of the short-haul rescuer during forward flight is greater than during a helicopter rappel. To minimize this exposure time, short-haul flights should be limited to the shortest possible flight distance practical.
- A key advantage of helicopter short-haul is that hover time is typically shorter than with heli-rappelling or static hoist rescue operations.
- Reliable clear radio communications are critical in addition to the use of standardized hand signals (Figure 42).
- The shadow generated by the load provides a reference for the pilot and spotter in determining the height of the short-haul load above the ground.
- Rescuer proficiency is easier to maintain with the short-haul technique than with helicopter rappelling, since short-haul requires fewer rescuer manipulations. However, pilot proficiency with precision placement is significantly more critical.
- A single line configuration for a short-haul line is most common with rescue organizations. Multiple line configurations create an added risk of entanglement when the lines become slack.

- It is recommended that auto-locking carabiners be used for all connection points, both at the aircraft and on the end of the line, which provides a positive means to prevent in-flight vibration from accidentally unlocking a carabiner.
- Rescue harness selection for short-haul operations should evaluate how the rescuer will fly when encumbered with a loaded pack (Figure 43). The best option is a configuration that does not require the rescuer to grasp the line to remain upright. This is accomplished by using a full-body harness with a sternal attachment point or a seat and chest harness with preconfigured straps (e.g. daisy chains) that can quickly be attached to the short-haul line. When not in use, these attachment straps create a possible entanglement hazard, if left dangling from the harness. Secure the loose ends immediately when the attachment straps are not in use.
- Knife or shears should be carried by all personnel and readily available in the event of line entanglement.
- FAA regulations, prohibit a person be carried as part of the external load under IFR conditions (14 CFR-Part 133.33[f]).

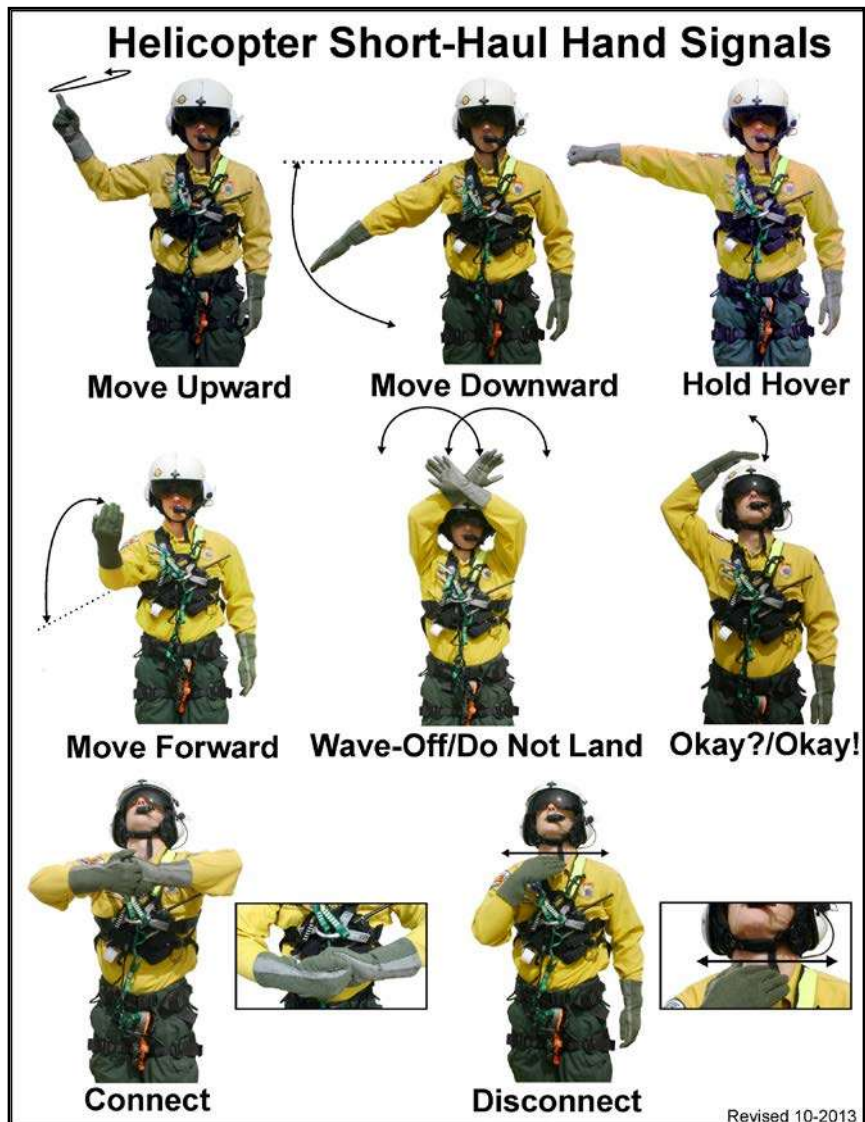

Figure 42- Short-haul Hand Signals. Courtesy Grand Canyon National Park SAR.

## Rescuer Head-to-toe Safety Checklist (HEC Techniques)

- **Helmet** - properly fitted, chin strap fastened.
- **Eye protection** - secured.
- **Fire resistant clothing** - collar up, flight suit zipped, and loose items around neck tucked in.
- **Radio** - operational and correct frequency selected.
- **Gloves** - on.
- **Sleeves** - down and secured over gloves.
- **Harness** - properly fitted, buckles correctly fastened, no twists, and loose straps secured. Double-check follow-through buckles. Means of attachment is properly secured to harness and locking carabiners are functional.
- **Knife** - easily accessible and secured.
- **Footwear** - Aviation Life Support Equipment (ALSE) approved
- **Top of boots covered** - pants or flight suit provides coverage in seated position, if riding in aircraft.



**Figure 43- Denali Short-Haul Training.** Well-equipped for the extreme conditions of a high altitude rescue operation, a rescuer conducts short-haul training at Denali National Park & Preserve. Image copyright Menno Boermans.

## Helicopter Short-Haul Checklist (Pre-Mission)

- **Cargo** - non essential items removed. Additional equipment secured.
- **Cabin** - configured for short-haul mission (e.g. doors removed, etc.)
- **Anchor** – anchor points and release system installed, tested, and secure.
- **Short-haul line** - correctly attached to primary and backup anchors.
- **Spotter attachment** - tether secure.
- **Seat belts** - secured and operational.
- **Radios** - operational (radio check performed) and correct frequency selected.
- **Intercom** - operational. (Use of a “hot microphone” is not advisable, due to other air traffic or ground personnel attempting to make radio contact).



## Helicopter Rescue Appliances

### Helicopter Rescue Bags

Designed for the specific purpose as an aerial patient transport device, helicopter rescue bags (heli-rescue bags) have proven themselves to be more aerodynamic than a rigid basket stretcher alone. Helicopter rescue bags, which have their origins in Europe, are non-rigid hammock-like stretchers typically constructed of Cordura™ and have suspension straps that join to a single connection point overhead (Figure 44). A rescue subject is well protected from rotor wash and environmental conditions when thoroughly packaged in the helicopter rescue bag, however some sort of spinal immobilization device (e.g. backboard or vacuum mattress) is required to provide the bag with rigidity. The stability of a helicopter rescue bag in flight makes it a superior choice for patient transport during a helicopter hoist or short-haul rescue in land SAR applications. A litter attendant can be attached from the master attachment point to be suspended adjacent to the stretcher (Figure 45).



**Figure 44- Bauman Bag Stretcher.** Image copyright CMC Rescue.



**Figure 45- Attendant rigged with Bauman Bag Stretcher.** NPS photo.

Many U.S. organizations employ the Canadian produced “Bauman Bag”. According to Mavis Bauman, the bag was initially sold to Banff National Park by her sewing firm, Rainy Day Equipment Ltd., in January 1980, after working closely with Peter Fuhrmann of Parks Canada beginning in the late 1970’s. He sought to obtain a better product over the cotton European “Jenny Bag” that his agency was employing at the time.<sup>54</sup>

Helicopter rescue bags are also commercially produced in Europe by Kong (Italy), Tyromont (Austria) and RedVac (Austria). The evolution of all helicopter rescue bags come from the “lifesaving rescue net” developed by Fritz Buhler of Swiss Air Rescue in 1966. Buhler designed this lightweight horizontal patient transport net, which was small enough to be carried in a rescuer’s pocket. Today REGA (Rettungsflugwacht - Garde Aérienne) aka Swiss Air-Rescue still actively employs this lightweight horizontal open net as one of their patient transport devices.

<sup>54</sup> Bauman, Mavis. Rainy Day Equipment Ltd.

## Collapsible Rescue Basket

The standard collapsible rescue basket (Figure 46), also referred to as McCauley Basket, is primarily designed for lifting one survivor at a time during a hoist rescue. There is a larger commercially produced version, which can transport more than one subject. Once the rescue basket is lowered to a subject, it can be easily utilized by a conscious and mobile individual without direct rescuer assistance. The basket, employed by the U.S. Coast Guard and U.S. Navy, has integrated flotation attached to the frame. Total weight is 39 lbs. (17.6kg).

Prior to deployment, the collapsed rescue basket is laid out on a flat surface and the upper frame is lifted straight up, then the four internal support brackets of the collapsible rescue basket are moved into a locked position, which maintain the deployed shape of the basket. The support bails are locked in place with a bail locking mechanism (Figure 47), which serves to keep them from dropping down when the helicopter hoist hook is not attached. The helicopter hoist hook is attached to the lifting eye of the rescue basket. A subject being transported in the net, positions themselves with their back against either end of the rescue basket.

When a rescuer is available to provide loading assistance, they should instruct the subject to keep all body parts inside the rescue basket, and not attempt to get out of the rescue basket until directed by the helicopter crew chief. When the rescue basket has been hoisted up to the aircraft, the helicopter crew chief simultaneously pulls the basket into aircraft cabin, while slowly reeling out with the hoist cable, until rescue basket is at a safe position within the cabin to safely unload a subject.

## Rescue Net (Billy Pugh Net)

The rescue net (Billy Pugh Net model 872-SF) is a standard rescue device utilized by the US Navy. With its flotation collar, it is deployed in the maritime environment for situations involving multiple subjects. The rescue net (Figures 48 and 49) can accommodate up to two survivors or one survivor accompanied by a rescue swimmer. Chemical light sticks can be attached to the rescue net at night. The rescue net is lightweight and may become unstable while hoisting down to the water due to winds or



**Figure 46- Collapsible Rescue Basket.** Folded configuration (top) for storage and open configuration (bottom) for deployment. Image copyright Lifesaving Systems Corp.



**Figure 47- Bail locking mechanism.** Must properly engaged on collapsible rescue basket to keep bails and lifting eyes properly aligned. Image copyright Lifesaving Systems Corp.



**Figure 49- Rescue Net.** Billy Pugh model 872-SF. Image copyright Life Support International.

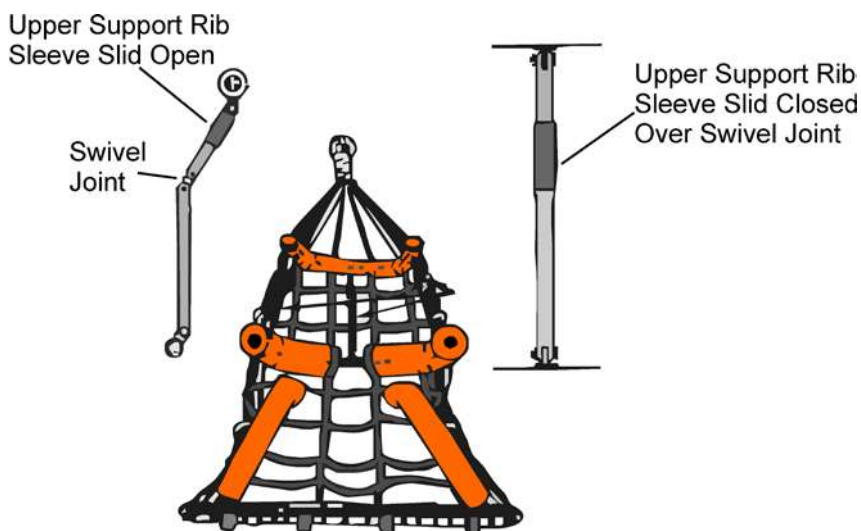

**Figure 48- Deployment of rescue net.** The net is readied for hoist deployment with locking sleeves slid over the rib supports to maintain the overall shape of the net. Illustration courtesy U.S. Navy.

rotor wash. Personnel ride seated unsecured in the net, which by design causes the subject's weight to tilt them to the rear of the net (Figure 50). Without rescuer assistance, it can be difficult for a subject to gain entry, since the net is designed to collapse, and an improperly positioned person can easily fall from the net.

The Navy follows a procedure during a hoist rescue, of bringing the net inside the aircraft doorway where the bottom of the net is attached to an anchor point with a "V" strap. This is secured, prior to having subjects exit the net, since the net could swing out, and away from the helicopter as the survivor exits the net endangering both the exiting survivor, and any personnel still inside the rescue net.<sup>55</sup> Weight 20 lbs. (9 kg) Open Dimensions H 54" (1.3m) x W 50" (1.2m) x L 35" (0.8m).



**Figure 50- Ice rescue with rescue net.** U.S. Park Police Bell 412 Helicopter performs hoist extraction with rescue net during ice rescue training with Montgomery County, MD, Department of Fire and Rescue Services Water Rescue Team. Park Police photo by Lt. David Schlosser, USPP.

<sup>55</sup> U.S. Navy SAR Manual 3-50.1, sec 1.4.4.3

## Medevac Litter

This litter, utilized by the U.S. Navy and U.S. Coast Guard, is suitable for rescues from confined areas, such as interior spaces of a ship, with its narrow profile (Figure 51). The litter has a system of flotation components to provide increased protection for a packaged subject during a maritime rescue. It is constructed of a tubular stainless steel frame and skids with a break-apart design. Sliding couplers are used to secure the two halves of the litter together. The Medevac litter can be hoisted in either vertical or horizontal positions. It is supplied with two litter bearer harnesses for carrying the litter on the ground. The litter weighs 32 lbs. (14.5 kg).

**Figure 51- Medevac Litter.** Shown configured for deployment and (right) stowed in storage bag. Image copyright Lifesaving Systems Corp.



## Rescue Seat or Forest Penetrator (Jungle Penetrator)

The rescue seat or forest penetrator (Figure 52) was developed during the Vietnam War (circa 1966) to replace the horse-collar lifting device being used at the time (which would not penetrate the vegetation canopy when deployed from a helicopter). This device is designed to accommodate up to three seated subjects for hoisting, however two is much more practical. It is attached by a ring at the top to a helicopter hoist hook. The rescue seat measures 34 inches (0.8m) long, 7 inches (17 cm) in diameter with the seat flanges folded, 26 inches (0.6m) in diameter with seat flanges extended, and weighs 23 pounds (10.4 kg). It has a rated capacity of 600 pounds (272 kg).

The unit is bright yellow for high visibility. Each seat is approximately 12 inches (30 cm) long and is spring loaded in the retracted position. A spring-loaded retaining latch under each seat secures the seat in the extended position (Figure 53). To release the seat from the extended position, push down on the seat and pull down on the latch. The seat will then snap back into the retracted position. Three webbing safety straps are available to secure

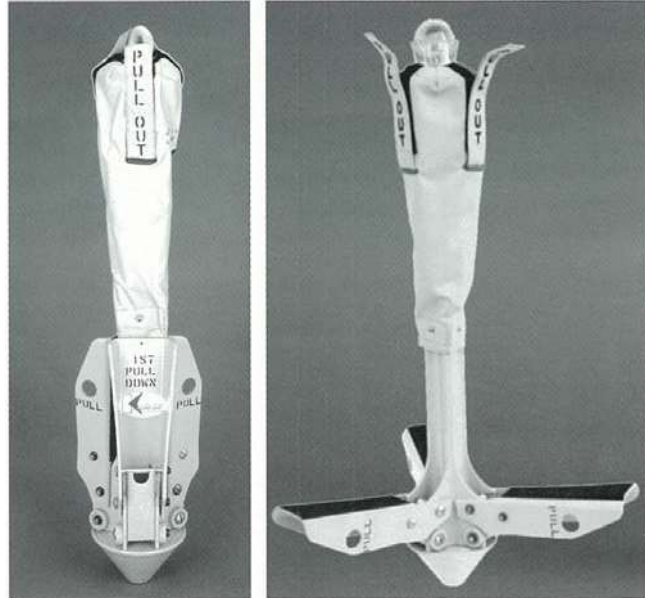

**Figure 52- Rescue Seat (Forest Penetrator).** Image copyright Kaman Aerospace.

subjects. The straps terminate with a yellow fabric marked TIGHTEN. Yellow webbing tabs, marked PULL OUT, are sewn to the safety straps and extend from one of three stowage openings. According to the manufacturer, a subject takes a seated position with one paddle beneath each leg so they are seated on two paddles.

The rescue seat should not be deployed to civilian subjects without the aid of a rescuer for safety. It is important the hoist cable not get entangled in any way prior to hoisting. Upon reaching the aircraft doorway, a seated subject should not be grabbed from the back, since it could cause them to slip off the rescue seat. When the subject is at the cabin door, facing away from the aircraft, the helicopter crewmember should place an arm around the subject's waist and the rescue seat and guide them backward into the aircraft cabin. Only one survivor, or one survivor accompanied by a rescuer is hoisted at one time, since it is difficult for a crew chief to recover two subjects into the aircraft alone. The rescue seat is utilized in the maritime and terrestrial environments, however it is unsuitable for deployment in technical exposed terrain (e.g. cliff rescue). It should also be employed with caution in a water rescue and is also unsuitable for deployment in a swiftwater environment.

A lightweight version of the traditional rescue seat (Figure 54) is manufactured by Lifesaving Systems Corporation, which is 18 lbs. (8 kg) and has a rated breaking strength 3,750 lbs. (1701 kg). Patterned after the military Forest Penetrator, the LSC Rescue Seat is equipped with two folding seats. Each fold-down seat is equipped with a safety strap on opposite sides of the float collar. The unit has been approved for use by the U.S. Navy and the U.S. Air Force.



**Figure 53- Rescue Seat (Forest Penetrator).** Shown (left) folded for insertion and (right) open for extraction. Image copyright Kaman Aerospace.



**Figure 54- Rescue Seat (Lightweight version).** Image copyright Lifesaving Systems Corp.

## Tag Line/Trail Line

The Navy employs a tag line that is deployed from a pre-rigged roll-up pouch (Figure 55). The terminus of the tag line has a weak link constructed with a loop of thin cord, which is attached to the equipment ring of the hoist hook assembly with a spring clip. The tag line is deployed from the helicopter by hand with a weight attached and gloves for ground personnel if required.

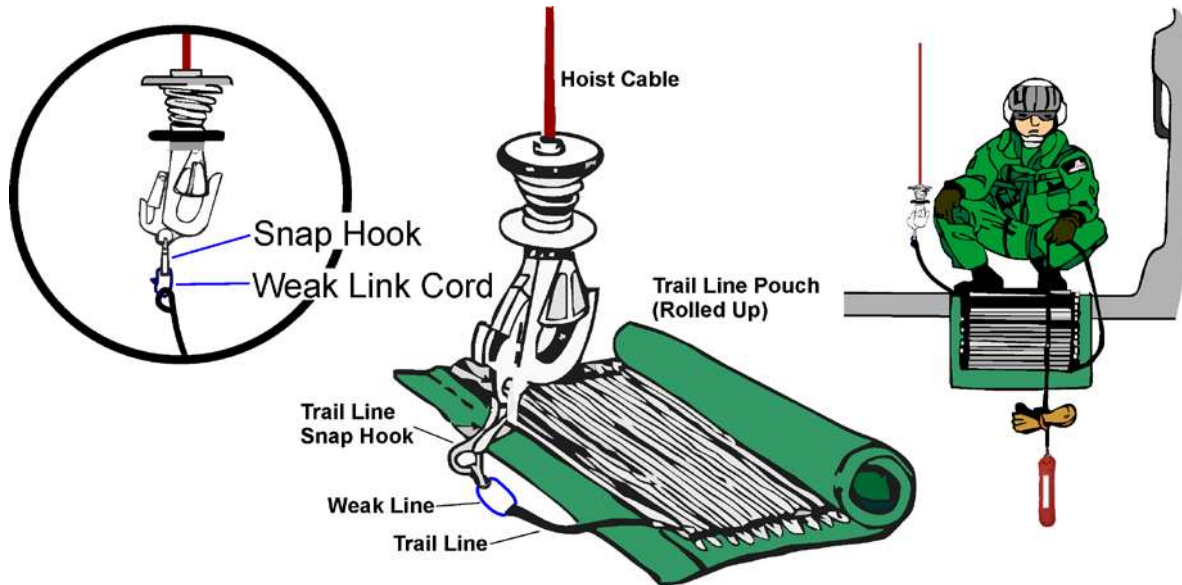

**Figure 55- Trail line deployment.** Deployment configuration from standard rollup trail line pouch. Compiled from U.S. Navy illustrations.

## Additional Personnel Lifting Devices

To avoid a mishap due to unfamiliar equipment, military procedures preclude hoisting a SAR victim utilizing their own personal harness.

### Rescue Strop

The rescue strop (aka "horse-collar") is designed as a retrieval device for uninjured personnel. The rescue strop fits around the chest of a single subject and is connected back to the rescue hook assembly (Figure 56). The strop is not meant to be utilized on victims who have sustained significant spinal injury unless the circumstances does not permit appropriately securing the injured subject in a more appropriate device. The strop is typically a buoyant device



**Figure 56- Rescue Strop.** Image copyright Lifesaving Systems Corp.

made with closed cell foam constructed with a high visibility external cover. A rescue subject should be instructed to keep their hands below shoulder level during extraction. An adjustable groin strap with an adjustable strap is used for greater security.

Another strop device manufactured by Aerial Machine and Tool, known as the Human Extraction and Lifting Device (HELD), can be placed on a subject in a closed or open configuration and allows cinching around the chest for a secure means of rescue or extraction (Figure 57). When placed around a subject the device can be secured without having to open the hoist hook gate.

**Caution: Deploying a rescue strop to a subject without the aid of a rescuer is not recommended. Rescue strop recovery without proper application has resulted in subjects falling out of the device during extraction with fatal consequences.**

A “hypothermic lift” (referred to as “double-lift method” by USN) is utilized for water rescue of hypothermic subjects. The rescue strop is used in conjunction with a second quick strop, placed in a manner to lift from behind the subject’s knees placing them in a semi semi-supine position.

### Quick Strop

The quick strop (Figure 58) is similar in design to the rescue strop. It is placed under the arms, around the back, or over the head of a subject. It can be deployed quickly around a subject. The quick strop has a friction slide that can snug the strop around the subject. There is a length-adjustable strap that is folded into a pocket on the back of the quick strop. The strap terminates in a snap hook. This strap is routed between the survivor’s legs and then clipped into the friction slide when the survivor is unconscious. Note: U.S. Coast Guard requires the use of the crotch strap when an unconscious, unresponsive, or incapacitated subject is being hoisted.<sup>56</sup>



Figure 57- Human Extraction and Lifting Device (HELD). Image copyright Aerial Machine and Tool.



Figure 58- Quick Strop. A slider buckle cinched down against the chest of a subject, used in conjunction with a groin strap, provides security during hoisting. Image copyright Lifesaving Systems Corp.

<sup>56</sup> U.S Coast Guard- Helicopter Rescue Swimmer Manual, page 2-14.

## Rescue Evacuation Triangle (Petzl Pitagor)

The Petzl Evacuation Triangle (Petzl Pitagor) is a quick application extraction seat, which can be used for hoist or short-haul extractions of a subject (Figure 59). It is designed to fit around adults and smaller subjects down to 44 lbs. (20 kg). The evacuation triangle is not designed to be utilized on victims who have sustained potential significant spinal injury unless the situation does not allow time to appropriately secure the victim's spine in a more appropriate device. For easy deployment, the Petzl label on the outside can be used to orient the product in the correct manner. Place the label upright in the center of the subject's back and then place their arms through the webbing loops. The adjustable yellow strap is brought through the subject's legs. All three metal lifting rings are then oriented without twists and secured together with an auto-locking carabiner. The evacuation triangle is designed for the evacuation of an upright subject and is utilized by non-DoD agencies. The triangle weighs 2.8 lbs. (1.29 kg) and has a rated strength of 20 kN (4,496 lbf.)



**Figure 59- Evacuation triangle.** Petzl Pitagor. NPS photo.

## Screamer Suit

The Bauman Screamer Suit (Figure 60), manufactured by Rainy Day Equipment, is a quick donning vest-style rescue device which permits rapid extrication of a subject by means of short-haul or hoisting. It holds the subject in a semi-seated manner and is not intended for a patient with a spinal injury or other injury requiring a litter evacuation. The device, which adjusts from small patients to large patients up to 500 lbs. (227 kg), avoids the delay associated with putting on a harness.



**Figure 60. Bauman Screamer Suit.** Quick donning rescue device designed for evacuation of a subject with limited injuries. Image copyright CMC Rescue.



## Hoisting Vest

The military hoisting vest (Figure 61) is constructed of lightweight nylon mesh material and is designed to accommodate one person. To ease donning and size adjustment of the vest, two adjustable torso straps are easily attached to the lifting V-Ring for hoisting. The vest takes up little room and is easily donned for transfer of uninjured or ambulatory personnel. It should not be utilized for water rescues.

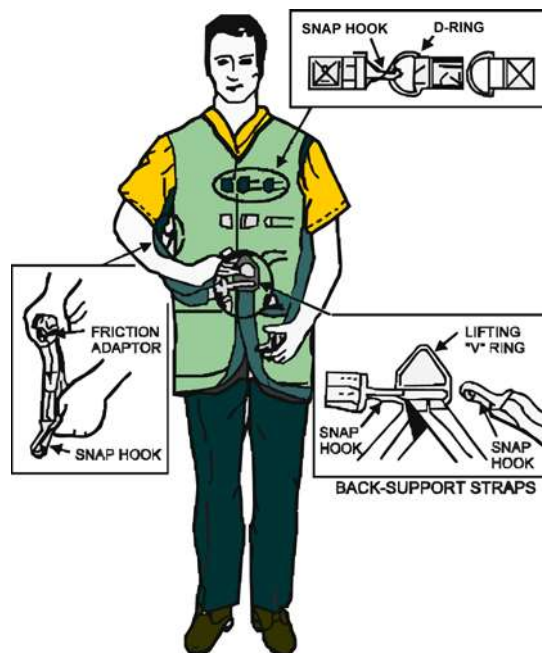

Figure 61- Military Hoisting Vest.  
Image courtesy U.S. Navy.

## Post Incident Considerations

### After-Action Review (AAR/Hot Wash/Hot Debrief)

At the conclusion of a helicopter rescue operation equipment needs to be rehabbed and repacked, however it is also crucial to review the effectiveness of the operation. The overall goal of any incident review is improve future responses, which prevents repeating known deficiencies and operational shortcomings. Conducting an after-action review (AAR) immediately at the conclusion of the incident effectively captures feedback from all involved personnel. The strength of immediacy in conducting the review is that personnel are actually more receptive then to discussing any flaws in the operation. With the passage of time, personnel develop mental justifications for less than optimal performance and are less receptive to discussions critical of their actions. Use an organized format to keep the AAR productive and on track (Box 8).

#### BOX 8. FORMAT FOR CONDUCTING AFTER-ACTION REVIEW:

- 1. What Was Planned?**
  - List the objectives and expected actions.
- 2. What Actually Happened?**
  - Review any actions that were not standard operating procedure for safety concerns.
- 3. Why Did It Happen?**
  - Discuss the reasons for ineffective or unsafe performance.
  - Concentrate on what, not who, is right.
- 4. What Can We Do Next Time?**
  - Identify effective and ineffective performance.
  - Determine how to apply the lessons learned to the next operation.

*Adapted from Incident Response Pocket Guide (NFES #1077), NIFC, Boise, ID.*

During the debriefing, focus on WHAT not WHO. When an operational deficiency is recognized attempt to identify the specific root cause so that appropriate corrective action can be implemented. Taiichi Ohno, visionary Toyota executive and an architect of the Toyota Production System, encouraged his staff to investigate the problem at the source and to “ask ‘why’ five times about every matter”.<sup>57</sup> It is a good technique to make sure that you are really getting down to the root cause of an issue. What truly caused that to happen?

*The helicopter rescue pack was missing some equipment. Why? The pack was not resupplied following the last incident. Why? The pack was left in a vehicle. Why? There is no formal equipment check-in established following a response. Why? Such a practice was not necessary in the past. Why? The team was smaller and the informal procedures were adequate...*

### **Incident Review**

Large-scale incidents, particularly those involving numerous agencies can be better managed through a formal incident review, which is truly a more formal AAR. This should be scheduled within a few days of the incident.

Considerations for a successful incident review:

- Extend invitations to representatives from all involved agencies.
- Utilize a comfortable location without distractions.
- Employ a neutral facilitator for a very large AAR event.
- Establish the ground rules. Encourage candor and openness. This is not a critique. It is an open and honest professional discussion.
- Adhere to an agenda or posted format that provides structure on what will be covered.
- Identify best practices and lessons learned.
- Address operational deficiencies.
- Capture action items for future improvement and who will address it with deadlines.
- Document the discussion points and distribute to the involved agencies.

### **Incident Review Points**

- **WAS IT SAFE?**
- **WAS IT EFFECTIVE?**
- **WAS IT EFFICIENT?**

Review the following factors:

- Policy & Procedures
- Training
- Resources & Equipment
- Command & Control

---

<sup>57</sup> Toyota Motor Corporation. Ask “Why” Five Times About Every Matter.

## Helicopter Rescue Training Considerations

1. Review your internal agency aviation guidelines and make sure that written operating procedures are current.
2. Conduct basic helicopter safety training for all personnel who will be involved in aviation activities.
3. Carry out pre-mission training with trained personnel and outside agencies for specific helicopter rescue techniques that will be used (Figure 62).
4. Employ a progressive training approach, evolving from classroom ground-based instruction, to mock-ups, and then finally operational training flights.
5. Include typical terrain training, which is as realistic, yet controlled, as possible. This helps highlight deficiencies in equipment or procedures that could become a problem during an actual mission.
6. Maintain skill proficiency on a regular and recurring basis. Without the benefit of repeated exposure to helicopter operations, personnel lose their composure and discipline.



**Figure 62- Helicopter Rescue Training.** Yosemite National Park SAR (YOSAR) personnel brief with California Highway Patrol AS350B3 crew from Fresno, California, prior to conduct hoist rescue training. NPS photo by Dave Pope.

## Summary

In April 1944, three downed British soldiers and an American airman in the battlefield of Burma heard the strange sound of an experimental Sikorsky YR-4 overhead. The pilot, Lt. Carter Harman of the U.S. Army Air Force, is credited with making this first recorded rescue operation involving a helicopter. In the heat and humidity Lt. Harman was only able to carry one passenger at a time to a sandbar airstrip ten miles away for a rendezvous with another aircraft. Harman conducted this heroic feat over 600 miles away from his base.<sup>58</sup>

---

<sup>58</sup> Friends of the Helicopter Museum, First Helicopter Combat Rescue.

## BOX 9. CHARACTERISTICS OF SAFE OPERATIONS

- Well briefed
- Clear desired results
- Clear team expectations
- Clear responsibilities
- Identification of available resources
- Established climate for learning
- Climate that values input
- Positive attitude/High morale
- High degree of accountability at all levels
- Atmosphere of self-critique

In more than half a century, helicopter rescue operations have greatly evolved and become more commonplace. Unfortunately, so have helicopter accidents. Studying helicopter rescue accidents, it quickly becomes apparent that the personnel involved in these missions had the best of intentions. These fellow professionals had no intention of becoming injured or dying in the line of duty. Unfortunately, decisions were often made that involved the sacred breach of safety procedures and the outcome cannot be reversed.

This text alone cannot provide all the insight and knowledge required to train personnel adequately in helicopter rescue techniques (Figure 63). It is essential that interested rescue personnel contact other agencies currently using these techniques to learn from experienced personnel. Aggressively seek out information, cross-train with other rescue units, and share ideas. Focus on managing a safe helicopter rescue program (Box 9).

*Progress slowly and cautiously in developing any helicopter rescue program. Improvisation in the middle of a rescue is a recipe for an accident.*

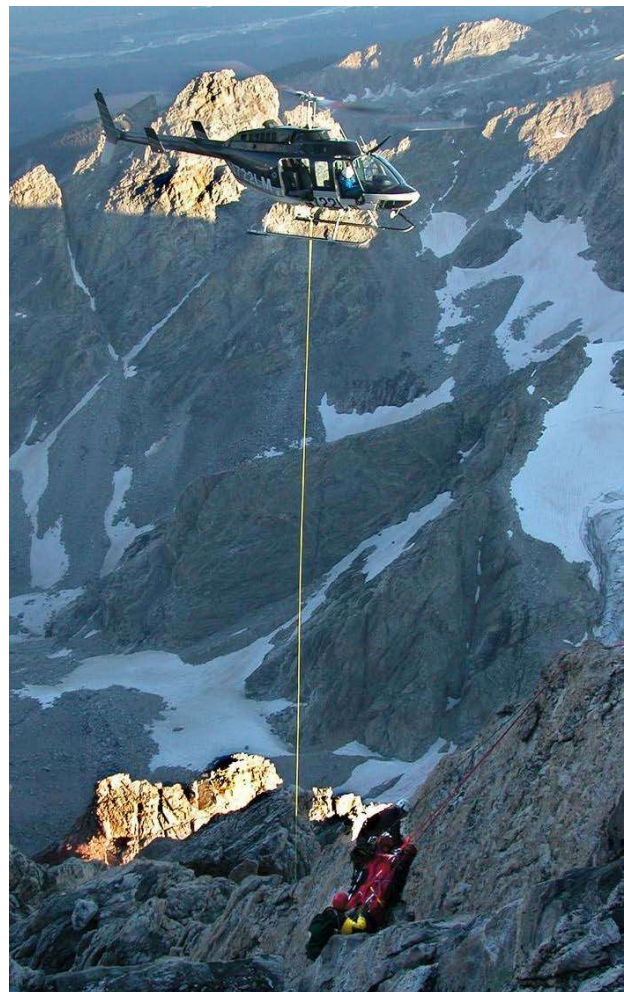

**Figure 63- Grand Teton Short-haul Rescue.** Lightning strike mass-casualty incident resulting in seven injured and one fatality at Grand Teton National Park. NPS photo by Leo Larson.

Finally, be disciplined with the use of a helicopter and avoid violating any safety practices as well as deviating from policies or procedures in the heat of battle.

## Bibliography

American Optometric Association (AOA). The Eye and Night Vision. [Article adapted from USAF Special Report, AL-SR-1992-0002, "Night Vision Manual for the Flight Surgeon", written by Robert E. Miller II, Col, USAF, (RET) and Thomas J. Tredici, Col, USAF, (RET)]. St Louis, MO. <http://www.aoa.org/optometrists/tools-and-resources/quick-reference-guides/aviation-vision/the-eye-and-night-vision>. Accessed September 1, 2013.

Australia Civil Aviation Safety Authority (CASA). Helicopter Personnel Winching. Airworthiness Article AAC 1-103 Canberra, ACT, Australia. 9/98. [http://www.casa.gov.au/scripts/nc.dll?WCMS:STANDARD::pc=PC\\_90746](http://www.casa.gov.au/scripts/nc.dll?WCMS:STANDARD::pc=PC_90746) Accessed August 8, 2013.

Baker, Susan, et al. EMS Helicopter Crashes: What Influences Fatal Outcome? Original research from John Hopkins University Bloomberg School of Medicine. Annals of Emergency Medicine. Dallas, TX. 2006.

Bauman, Mavis. Owner. Rainy Day Equipment Ltd. Nakusp, B.C. Canada. Personal interview. January 4, 2012.

Croucher, Phil. The Helicopter Pilot's Handbook. Electrocutation Technical Publishers Calgary, Alberta, Canada. 2008.

Department of Defense. U.S. Army. Concept Evaluation of UH-60 Externally Mounted Rescue Hoist. U.S. Army Aeromedical Research Laboratory, Fort Rucker, AL. 1991.

Department of Defense. U.S. Navy. Navy Search and Rescue Manual NTTP 3-50.1. Office of the Chief of Naval Operations. Washington, DC. April 2009 edition. [http://www.public.navy.mil/surfor/Documents/3-50-1\\_SAR.pdf](http://www.public.navy.mil/surfor/Documents/3-50-1_SAR.pdf) Accessed August 9, 2013.

Department of Defense. Wire Rope- Steel- Nonrotating for Aircraft Rescue Hoist. Military Specification MIL-W-83140 [1]. April 1969. Washington, DC. [http://www.everyspec.com/MIL-SPECS/MIL-SPECS-MIL-W/MIL-W-83140\\_34437/](http://www.everyspec.com/MIL-SPECS/MIL-SPECS-MIL-W/MIL-W-83140_34437/) Accessed August 8, 2013.

Department of the Interior. Basic Aviation Safety. Office of Aircraft Services, Boise, ID NFES #2097, April 1997.

Department of the Interior. Short-haul Handbook (351 DM1). Office of Aircraft Services, Boise ID. 02-2010 <http://oas.doi.gov/library/handbooks/library/Short-Haul+Handbook+Feb2010.pdf> Accessed August 8, 2013

Department of the Interior. Interagency Helicopter Rappel Guide. Office of Aircraft Service, Boise, ID. November 1990 edition.

Doyle, Patrick. Engineer. Breeze-Eastern Corporation. Whippany, NJ. Personal interview. September 23, 2013.

Environmental Protection Agency. Electric and Magnetic Fields (EMF) Radiation from Power Lines. Washington, DC. 2012. <http://www.epa.gov/radtown/power-lines.html> Accessed October 9, 2013.

Epilepsy Society (United Kingdom). Photosensitive Epilepsy. Buckinghamshire, UK. 2012. <http://www.epilepsysociety.org.uk/photosensitive-epilepsy> Accessed October 22, 2013.

Federal Aviation Administration. Crew Resource Management Training. Advisory Circular 120-51E. U.S. Department of Transportation. Washington, DC. 2004

Federal Aviation Administration, FAA Rotorcraft Flying Handbook, U.S. Department Of Transportation, Federal Aviation Administration, Flight Standards Service, Washington, DC. 2000.

Federal Aviation Administration, Government Aircraft Operations. Advisory Circular 00-1.1. U.S. Department of Transportation. Washington, DC. 1995.

[http://www.faa.gov/documentLibrary/media/Advisory\\_Circular/AC%2000-1.1.pdf](http://www.faa.gov/documentLibrary/media/Advisory_Circular/AC%2000-1.1.pdf)  
Accessed September 2, 2013.

Friends of The Helicopter Museum . The First Helicopter Combat Rescue, Somerset, UK. <http://www.hmfriends.org.uk/combatresearch65th.htm> Accessed July 31, 2013.

Globalsecurity.org website. Night Vision Goggles (NVG). 07-2011.

<http://www.globalsecurity.org/military/systems/ground/nvg.htm> Accessed August 8, 2013.

Harrington, Nick. Aviation Safety Inspector. Federal Aviation Administration, Flight Standards District Office (FSDO). Las Vegas, NV. Personal interview, June 14, 2002.

Harris, Kim. Director of Operations. Aviation Specialties Unlimited. Boise, ID. Personal interview. December 22, 2011.

Holleran, Reneé Semonin. ASTNA (Air and Surface Transport Nurses Association) Patient Transport: Principles and Practice, Fourth edition, Mosby Elsevier, St Louis, MO. 2009.

Joint Aviation Authorities (JAA) JAR-OPS Part 3. Commercial Air Transportation (Helicopters), Hoofddorp, Netherlands. <http://www.jaa.nl/publications/section1.html>, Accessed August 8, 2013.

Loukopoulos, Loukia, R. Key Dismukes, and Immanuel Barshi. The Multitasking Myth. Ashgate. Farnham, Surrey, UK. 2009.

Martin, Adam. Aeronautical Engineer, Advanced Design Division, Sikorsky Aircraft Corp. Stratford, CT. Personal interview, June 7, 2002.

Marty, Sid. Men for the Mountains. McClelland & Stewart Ltd. Toronto, Ontario. Canada. 1978.

Mertel, Kenneth. Airmobile-style rappel and troop ladder, US Army Aviation Digest, U.S. Army, Fort Rucker, AL (15-2), 10-13, February 1969.

Mitchell, Michael. President. Zephyr International LLC. Conway, SC. Personal correspondence. 2012.

Montenegro James, Lead Quality Engineer, Gentex Corp: Personal interview, Carbondale, PA. January 3, 2012.

National Park Service. Serious Accident Investigation: Factual Report. Falling Fatality of NPS Rescue Climber on Emmons-Winthrop Glacier Within Mount Rainier National Park- June 21,2012. Ashford, WA. 2012

National Wildfire Coordinating Group Sponsored (NWCG). Incident Response Pocket Guide. National Interagency Fire Center (NIFC), Boise, ID. January 2010. NFES # 1077. <http://www.nwcg.gov/pms/pubs/nfes1077/nfes1077.pdf> Accessed August 8, 2013.

National Wildfire Coordinating Group (NWCG), Interagency Helicopter Operations Guide (IHOG), NFES 1885, National Interagency Fire Center (NIFC), Boise, ID. February 2013. [http://www.nifc.gov/aviation/av\\_ref\\_ihog.html](http://www.nifc.gov/aviation/av_ref_ihog.html) Accessed August 8, 2013.

PBI Performance Products, Inc., PBI Properties, Charlotte, NC. <http://www.pbiproducts.com/international/en/pbi-advantage/properties/> Accessed October 6, 2013.

Phillips, Ken. Unpublished analysis of Helicopter Rescue Accidents; International Commission for Alpine Rescue (IKAR); 2001-2011 Air Rescue Reports. 2011.

Pushies, Fred. U.S. Army Special Forces: The Power Series. Motorbooks International. St Paul, MN. 2001.

REGA (Swiss Air-Rescue), About Us- History. Zurich, Switzerland. 08-201. <http://www.rega.ch/en/about-us/history.aspx> Accessed August 8, 2013.

Sikorsky Archives. Rescue Award- First Civilian Helicopter Rescue. Igor I. Sikorsky Historical Archives, Inc., Stratford, CT. Updated September 2012. [http://www.sikorskyarchives.com/Rescue\\_Award.php](http://www.sikorskyarchives.com/Rescue_Award.php) Accessed July 31, 2013.

Stern and Stern Industries, Inc. - Fabric Weaving Specialists. Nomex® Fabric. Hornell, NY. 2013. <http://www.sternandstern.com/category/53/Nomex-Fabric.html> Accessed October 6, 2013.

Teel, William. Senior Design Engineer, Goodrich Corporation; Sensors & Integrated Systems (Hoist & Winch). Diamond Bar, CA. Personal interview. January 13, 2012.

Toyota Motor Corporation. Ask “Why” Five Times About Every Matter. Aichi, Japan. [http://www.toyota-global.com/company/toyota\\_traditions/quality/mar\\_apr\\_2006.html](http://www.toyota-global.com/company/toyota_traditions/quality/mar_apr_2006.html). Accessed May 19, 2012.

TSL Rescue. Product catalogue, 2013. Ed 13-01. Alex, France. <http://www.tsrescue.com> Accessed October 22, 2013.

United Nations Logistics Base- Regional Aviation Safety Office. Night Vision Goggles (NVGs) Limitations. Aviation Safety Awareness Information. Vol. 4, Issue 10. Brindisi, Italy. <http://www.unlb.org/AviationSafety/Details.asp?AsmID=19> Accessed October 8, 2013.

U.S. Coast Guard. Coast Guard Helicopter Rescue Swimmer Manual. COMDTINST M3710.4C. Washington, DC. April 22, 2011.

U.S. Coast Guard. “Operational Risk Management.” Commandant Instruction 3500.3. Department of Transportation. Washington, DC. Nov 23, 1999. [http://www.uscg.mil/directives/ci/3000-3999/Ci\\_3500\\_3.pdf](http://www.uscg.mil/directives/ci/3000-3999/Ci_3500_3.pdf) Accessed August 7, 2013.

U.S. Forest Service, Preliminary Aircraft Accident Investigation Report- Appendix D; Human Factors Analysis , Willow Helibase Rappel Accident July 21, 2009, Six Rivers National Forest, Willow Creek, CA. Released October 19, 2009.

U.S. Government, Code of Federal Regulations (CFR). Title 14- Part 27 Federal Aviation Regulations (FAR). Washington, DC. Amended 1999.

Wadock, Alan J. and Lindsay A. Ewing, Eduardo Solis, Mark Potsdam, Ganesh Rajagopalan. Rotorcraft Downwash Flow Field Study to Understand the Aerodynamics of Helicopter Brownout. NASA Ames Research Center. Presented at the American Helicopter Society Southwest Region Technical Specialists’ Meeting, “Technologies for the Next Generation of Vertical Lift Aircraft,” Dallas-Fort Worth, TX, October 15-17, 2008.

Wiener, Earl, Barbara Kanaki, and Robert Helmreich. Cockpit Resource Management. Academic Press. San Diego, CA. 1993.



## Suggested Reading and Resources

Chartres John. Helicopter Rescue. Ian Allan Ltd. Surrey, London, UK. 1980,

Department of the Interior. Aviation Policy: Departmental Manual 350 through 353. Office of the Secretary of the Interior, Washington, DC., December 26, 1996.  
<http://amd.nbc.gov/library/dm/index.htm> Accessed January 30, 2012

Department of Interior, Office of Aircraft Services (OAS). <http://oas.doi.gov/>  
Accessed August 6, 2013.

Helicopter Rescue and Response Association (HRRRA):  
<http://helirescueassociation.org/> Accessed January 30, 2012.

Phillips, Ken. Short-haul Helicopter Rescue, Rescue Magazine 6(3): 30-41, May/June 1993, JEMS Communication, Carlsbad, CA.

Phillips, Ken. Helicopter Safety, Rescue Magazine 10(1): 38-44, January/February 1997, JEMS Communication, Carlsbad, CA.

Shimanski, Charlie. Helicopters In Search and Rescue Operations: Basic and Intermediate Levels. Mountain Rescue Association. 2008  
<http://www.mra.org/training/mountain-rescue-training>. Accessed July 24, 2013.

US Department of Transportation, Federal Aviation Administration: Federal aviation regulations (FAR), electronic CFR: title 14—Aeronautics and space:  
[http://ecfr.gpoaccess.gov/cgi/t/text/text-idx?c=ecfr&tpl=/ecfrbrowse/Title14/14tab\\_02.tpl](http://ecfr.gpoaccess.gov/cgi/t/text/text-idx?c=ecfr&tpl=/ecfrbrowse/Title14/14tab_02.tpl)  
Accessed January 30, 2012.

## Glossary

**After-Action Review (AAR)-** A formal operational review, conducted in a controlled setting, to review the best practices and any identified deficiencies associated with an incident along with possible corrective actions. This process should include personnel from all involved agencies and can be conducted several days following an incident.

**Air Traffic Control (ATC)-** A service provided to pilots by ground-based controllers who direct aircraft on the ground and through controlled airspace, and can provide advisory services in non-controlled airspace. The primary purpose of ATC is to prevent collisions, organize and expedite the flow of traffic, and provide information and other support for pilots.

**Autorotation-** A rotorcraft flight condition in which the lifting rotor is driven entirely by the action of the air while the rotorcraft is in motion. No engine power is supplied to the main rotor, and lift is developed from the free turning of the rotor blades, which are driven by aerodynamic forces. Rotor inertia is used as the helicopter nears the ground to control the descent.

**Aviation Life Support Equipment (ALSE)-** All related survival, protective emergency, and rescue devices employed to provide personal protection for aviation crewmembers. This includes, but is not limited to flight helmets, flight suits, harnesses, personal locator beacons, life vest, etc.

**Basic Empty Weight-** The starting point for weight computations is the basic empty weight, which is the weight of the standard helicopter, optional equipment, unusable fuel, and full operating fluids including full engine oil.

**Bingo Fuel-** A pre-briefed amount of fuel for an aircraft that would allow a safe return to the base of intended landing.

**CASEVAC (Casualty evacuation)-** Military term for the emergency patient evacuation of casualties from a combat zone. Military call sign "Dustoff." The difference between a CASEVAC and a medical evacuation (MEDEVAC) is that a MEDEVAC uses a standardized and dedicated medical vehicle providing en route care. On the other hand, CASEVAC uses non-standardized and non-dedicated vehicles that may not be able to provide enroute care.

**Center of Gravity (CG)-** The point in a helicopter where all forces are balanced. In a single-rotor helicopter, this is a range forward or aft beneath the rotor mast. The distribution of the weight of the fuel, the personnel, and the cargo in the helicopter affects this critical balance for safe flight.

**Clear Text-** A spoken communication style that avoids the use of any abbreviated codes in order to facilitate understanding by all emergency personnel.

**Combat Search And Rescue (CSAR)**- Operations conducted in the battlefield to rescue or perform medical evacuations of military personnel.

**Collective Pitch System**- The flight control mechanisms by which the pitch of all rotor blades is varied equally and simultaneously. The collective pitch control regulates the pitch angle of the main rotor blades. It is used as the primary power control. As the pitch of the blades is increased, lift is induced, causing the helicopter to lift off the ground, hover, or climb, as long as power is available.

**Controlled Flight into Terrain (CFIT)**- Accident occurring when an airworthy aircraft under the complete control of the pilot is inadvertently flown into terrain, water, or an obstacle. The pilots are generally unaware of the danger until it is too late. Many CFIT accidents occur because of loss of situational awareness.

**Crew Engineer (CE) or “Crew Chief”**- Flight crewmember who performs maintenance on the aircraft (military) and performs rescue duties, such as operation of the helicopter hoist.

**Crew Resource Management (CRM)**- Initially known as cockpit resource management, crew resource management involves the application of team management concepts to reduce human error and improve safety, particularly in high risk environments. CRM emphasizes team effectiveness by enhancing individual and aircrew performance in communication, situational awareness, effective leadership and management, and crew coordination. CRM makes optimum use of all available resources - equipment, procedures and people - to promote safety and improve situational awareness.

**Cyclic**- The flight control mechanism that permits the helicopter to move forward, sideways, and backward by corresponding tilting of the rotor disc.

**Density Altitude (DA)**- The actual pressure altitude corrected for temperature and humidity, which provides a measure of the air density. The higher the DA, the less lift a helicopter can achieve. Higher temperatures or higher elevation cause the air to be less dense, resulting in less lift for the rotor blades.

**Distance Measuring Equipment (DME)**- A navigation means employing a VOR or ILS localizer beacon to enable aircraft to measure their position relative to that beacon. Aircraft send out a signal, which is sent back after a fixed delay by the DME ground equipment.

**Dynamic Rollover**- Dynamic rollover occurs when some factor causes the helicopter to roll or pivot around a skid, or landing gear wheel, until its critical rollover angle is reached. If the critical rollover angle is exceeded, the helicopter rolls on its side regardless of the cyclic control corrections made. Dynamic rollover may also occur if the pilot does not use the proper landing or takeoff technique or while performing slope operations. Dynamic rollover can occur in both skid and wheel equipped helicopters, and all types of rotor systems.

**Fast Rope Insertion/Extraction System (FRIES)-** A combat or tactical helicopter deployment technique, also known as “fast roping”. Not traditionally considered a SAR technique.

**Flight Following-** The method and process by which an aircraft is tracked from departure point to destination. Flight following is the knowledge of the aircraft and condition with a reasonable degree of certainty such that, in the event of mishap, those on board may be rescued in a timely manner. It is typically accomplished through a position check on the radio at regular intervals.

**Fuel Weight-** The weight of the onboard aircraft fuel load. Domestically Jet-A is used within the U.S. for turbine helicopters, which is 6.8 pounds per (US) gallon. JP-8 is a jet fuel, which is less flammable and safer for combat survivability, specified and used widely by the US military. The U.S. Navy uses a similar formula, JP-5.

**GAR (Green-Amber-Red) Risk Assessment Model-** Assessment tool that surveys the perceived risk for an activity, and most importantly, facilitates open discussion by participants. Employing a numerical rating for elements of the activity the total risk score is characterized as green-go, amber-caution or red-stop. The strength of the model is found in the group discussion on risk that is generated by the process.

**Gross Weight-** The sum of the basic empty weight and useful load.

**Ground Effect-** When a helicopter is in a low hover, the ground interrupts the airflow under the helicopter, and the velocity of the induced airflow to the rotor system is reduced. The result is less induced drag and a more vertical lift vector. This ground cushion, or ground effect, is beneficial in flight because it increases lift capability for the helicopter, which therefore requires less power to maintain a hover. Ground effect occurs when the helicopter is at a very low altitude, usually one half the rotor diameter. Ground effect is hampered by uneven terrain, vegetation, or water beneath the rotor disc.

**Heavy Helicopter-** A helicopter with a certified gross weight greater than 12,500 pounds (5,670 kg). Under the ICS helicopter typing system, a heavy helicopter is a Type 1 helicopter; it must have an allowable payload at 59°F (15°C) at sea level of 5,000 pounds (2,268 kg) and capability of 15 or more passenger seats.

**Height-Velocity Curve-** A chart in the helicopter flight manual that indicates the combinations of altitude and forward airspeed required to ensure a safe autorotation.

**Helibase-** Under the incident command system (ICS), a designated facility for conducting helicopter operations that has refueling capability. The U.S. Federal Aviation Administration (FAA) term for a permanent helicopter facility is heliport.

**Helicopter-** A rotorcraft that depends principally on its engine-driven rotors for vertical and horizontal motion.

**Helicopter Emergency Medical Services (HEMS)-** A civil or public helicopter operation with a dedicated function of conducting aeromedical patient care and transport.

**Helicopter Rappel-** Insertion of personnel at a site by means of rappelling on a fixed rope from a helicopter in a hover.

**Helispot-** A temporary helicopter landing zone (LZ), which may incorporate a natural or an improved takeoff and landing area.

**High Frequency (HF)-** The spectrum of radio frequencies in the 3 MHz to 30 MHz range.

**Hoist Rescue-** Insertion or extraction of personnel on a lightweight cable using an electric or hydraulic hoist that is anchored to a helicopter.

**Hot Debrief (Hot Wash)-** The immediate review after an emergency response operation, conducted with involved personnel, to identify operational deficiencies and planned corrective actions. Conducted immediately at the conclusion of the operational assignment.

**Hover-** A condition of flight in which the helicopter remains fairly stationary over a given point, moving neither vertically nor horizontally.

**Hover Ceiling-** The highest altitude at which a helicopter can successfully hover while loaded to its maximum gross weight. In and out of ground effect hover ceilings are computed at maximum gross weight.

**Hover in Ground Effect (HIGE)-** To operate at an altitude (usually equal to one half the rotor diameter above the surface) at which the positive influence of ground effect is attained.

**Hover Landing-** A landing that does not meet the definition of toe-in, single-skid, or step-out landings. Hover landings are characterized by a need to maintain a substantial amount of hover power while the landing gear is not in contact with the surface. Hover landings normally are required because of the nature of the surface (e.g., swampy ground, tundra or muskeg, snow, or lava rock).

**Hover Out of Ground Effect (HOGE)-** Hovering at a high enough altitude that the added benefit of ground effect is not obtained.

**Human External Cargo (HEC)-** Lifting and transport of personnel outside or beneath a helicopter during flight (e.g. hoist rescue or short-haul)

**Human Factors-** A discipline of study that deals with the psychological, social, physical, biological and safety characteristics of a user and the system they are in, such as the human-machine interface.

**Incident Command System (ICS)-** A standardized command and control framework which is utilized nationwide to many emergency and all-hazard incidents. For additional information refer to FEMA website; <http://www.fema.gov/incident-command-system>.

**Instrument Flight Rules (IFR)-** FAA rules governing the operation of aircraft in weather conditions below the minimum for flight under visual flight rules; that is, conditions under which instruments are essential for flight navigation.

**Instrument Meteorological Conditions (IMC)-** The weather conditions including visibility, cloud distance, cloud ceilings, and weather phenomena that cause visual conditions to drop below minimum required to operate by visual flight referencing. IMC refers to the physical weather, while IFR represents the regulations and restrictions that a pilot must observe.

**Klick-** military slang: kilometer.

**Knot (kt)-** A unit of speed equal to one nautical mile (1.852 km) per hour, approximately 1.15 statute miles per hour.

**Landing Zone (LZ)-** Any improved or unimproved helicopter landing site that has an adequate touchdown pad and approach and departure paths. Under ICS, a landing zone is referred to as a helispot or helibase.

**Light Helicopter-** A helicopter with a certified gross weight of less than 6,000 pounds (2,721 kg). Under the ICS helicopter typing system, a light helicopter is a Type 3 helicopter; it must have an allowable payload at 59° F (15° C) at sea level of 1,200 pounds (544 kg) and four to eight passenger seats.

**Load Calculation-** Calculation of the helicopter's lifting capability for a given altitude and temperature.

**Longline-** A line or set of lines, including steel cable or synthetic material, used for external sling load operations to deliver supplies to a site where a helicopter could not safely land.

**Low-Level Operations-** Flight conducted below 500 feet AGL.

**LZ-** slang: landing zone

**Maximum Gross Weight-** The certified maximum allowable weight of an aircraft, as determined by the manufacturer and approved by the FAA, at which that particular aircraft can safely fly. This weight is the equipped weight of the aircraft plus that of the useful load (i.e., pilot, passengers, cargo, and fuel). Most helicopters have an internal

maximum gross weight, which refers to the weight within the helicopter structure and an external maximum gross weight, which refers to the weight of the helicopter with an external load.

**Maximum Performance Takeoff-** A steep ascent upon takeoff, done to clear obstacles, that involves limited forward airspeed and that approaches the flight limitations of the helicopter.

**MEDEVAC (medical evacuation)-** The timely, efficient movement and en route care by medical personnel of the wounded, injured, and ill persons, from the battlefield and other locations to treatment facilities. The difference between a CASEVAC (casualty evacuation) and a MEDEVAC is that a MEDEVAC uses a standardized and dedicated vehicle providing en route care. On the other hand, a CASEVAC uses non-standardized and non-dedicated aircraft that may not provide enroute care. Military MEDEVAC aircraft are mandated by the Geneva Convention to be unarmed and well marked.

**Medium Helicopter-** A helicopter with a certified gross weight between 6,000 pounds (2,721 kg) and 12,500 pounds (5,669 kg). Under the ICS helicopter typing system, a medium helicopter is a Type 2 helicopter; it must have an allowable payload at 59° F (15° C) at sea level of 2,500 pounds (1,134 kg) and nine to 14 passenger seats (unless it is in a restricted category).

**Military Training Routes (MTR)-** Designated aerial corridors in which military aircraft can operate below 10,000 feet faster than the maximum safe speed of 250 knots that all other aircraft are restricted to while operating below 10,000 feet. The routes provide for high-speed, low-level military activities.

**Military Operations Areas (MOA)-** A military operations area (MOA) is airspace designated outside of Class A airspace, to separate or segregate certain nonhazardous military activities from IFR traffic and to identify for VFR traffic where these activities are conducted. MOA's do not restrict VFR operations, however pilots operating under VFR should exercise extreme caution while flying within, near, or below an active MOA. Additionally, prior to entering an active MOA, pilots should contact the controlling agency for traffic advisories due to the frequently changing status of these areas.

**Notice to Airmen (NOTAM)-** A notice typically transmitted by an aviation authority (FAA) to alert aircraft pilots of potential hazards along a flight route or at a location that could affect the safety of the flight.

**One-Skid Landing-** The maneuver of placing one skid of the helicopter on the ground, while the other remains above the ground, typically performed in steep terrain. When the skid is in contact with the ground, it serves as a pivot point and the CG can shift laterally.

**Operational Risk Management (ORM)-** A cyclic process of risk assessment, risk decision-making, and implementation of risk controls, which results in acceptance, mitigation, or avoidance of risk.

**Operational Control (OPCON)-** The authority to perform functions of command over subordinate forces involving organizing and employing commands and forces, assigning tasks, designating objectives, and giving authoritative direction necessary to accomplish the mission.

**Pararescue, aka Pararescue Jumpers (PJ's)-** United States Air Force Special Operations Command (AFSOC) and Air Combat Command (ACC) personnel tasked with recovery and medical treatment of personnel, commonly by helicopter or parachute operations, in humanitarian and combat environments.

**PAX-** military slang: passengers.

**Payload-** The weight of the passengers and cargo.

**Pilot in Command (PIC)-** The person who (1) has final authority and responsibility for the operation and safety of the flight; (2) has been designated as pilot in command before or during the flight; and (3) holds the appropriate category, class, and type rating, if appropriate, for the conduct of the flight.

**Pilot Flying (PF)-** Designated pilot who takes direct responsibility for flying the aircraft for the complete flight or for particular parts of it such as the Descent/Approach and Landing. The other pilot is then designated for that sector or relevant parts of it as 'Pilot Not Flying' (PNF) or 'Pilot Monitoring' (PM), and in that role must monitor the flight management and aircraft control actions of the PF and carry out support duties such as communications and check-list reading.

**Power-On Landing-** A landing maneuver in which both skids are in full contact with the ground while full power is maintained; this maneuver is performed to maintain the position of the aircraft on a marginal touchdown pad.

**Precautionary Landing-** A landing conducted by the pilot because of an apparent failure of the helicopter flight systems, which would make continued flight unsafe.

**Public Aircraft-** A government-owned, leased, or hired aircraft that is performing work "exclusively in the service" of any federal, state, or local government agency.

**Recon-** slang: reconnaissance

**Rescue Coordination Center (RCC)-** A primary search and rescue facility staffed by supervisory personnel and equipped for coordinating and controlling search and rescue operations. Rescue Coordination Centers (RCCs) in the United States are operated by the United States Coast Guard and the U.S. Air Force. RCC's are responsible for a geographic area, known as a "search and rescue region of responsibility" (SRR). SRR's are designated by the International Maritime Organization (IMO) and the International Civil Aviation Organization (ICAO).



**RF-** slang: radio frequency

**Safety Circle-** An obstruction-free area on all sides of the helicopter touchdown pad that allows a safe approach to and departure from the touchdown pad.

**SATCOM-** slang: satellite communication. Geosynchronous communications satellites that provide television, voice, and data transmissions.

**Short-haul-** The transport of one or more people externally suspended on a line below a helicopter. Includes the use of a helicopter and an externally attached line to insert or extract personnel in areas that preclude a normal landing.

**Situational Awareness (SA)-** The ability of an individual to know what is going on around himself or herself at all times. Situational awareness is maintained by obtaining updated information about the external environment and about all operational conditions in order to form an accurate mental image of a mission. During emergency operations, responders' ability to maintain situational awareness is diminished by stress, poor communications, and overtasking.

**Sling Load-** An external load supported by a sling, net, bag, or some combination of these that is attached with a long-line to the helicopter by means of a cargo hook.

**Sortie-** One aircraft takeoff and landing to conduct a mission.

**Step-Out Landing-** A landing used for dropping off or picking up passengers and cargo (other than the rappel/short-haul method) while the helicopter is held in a hover. The helicopter is not in contact with the ground, and the center of gravity can shift laterally and longitudinally.

**Supplemental Type Certificate (STC)-** The airworthiness approval required by the FAA (FAR\* – 14 CFR Chapter 1 Part 21.113) when a design modification involves a change in materials, parts, and appliances on the aircraft. Rescue equipment, which is attached to a helicopter, is affected by the scope of this requirement.

**Technical Standard Order (TSO)-** A minimum performance standard approval issued by the FAA for specified materials, parts, processes, and appliances used on civil aircraft.

**Temporary Flight Restriction (TFR)-** Airspace restriction to flight imposed in order to:

1. Protect persons and property from an existing or imminent flight associated hazard
2. Provide a safe environment for the operation of disaster relief aircraft
3. Prevent an unsafe congestion of sightseeing aircraft above an incident
4. Protect the President, Vice President, or other public figures
5. Provide a safe environment for space agency operations

TFRs are, by definition, "temporary" in nature, and pilots are expected to check appropriate NOTAMs during flight planning when conducting flight in an area where a temporary flight restriction is in effect.

**Touchdown Pad-** A designated area, which may have a prepared or improved surface, where the helicopter skids are placed.

**Toe-In Landing-** A landing maneuver in which the helicopter rests on the toes of the skids; toe-in landings are used to drop off or pick up passengers or cargo. To execute the maneuver, a significant amount of hover power (within 15% of hover power) must be held to keep the helicopter from falling backward. When the helicopter is operated in this manner, the potential exists for a significant lateral and longitudinal shift in the CG shift during loading and offloading. In addition, when the helicopter is balanced on the forward one third or less of the skid tube, main rotor blade clearance is another significant concern.

**Torque-** A twisting force that causes a counter-rotating motion. In a helicopter with a main rotor that rotates counterclockwise, the fuselage rotates clockwise. The tail rotor produces anti-torque to counteract this force. The maximum continuous upper torque limit is 100%; however, a transient over-torque may be tolerable to the helicopter power plant.

**Translational Lift-** The additional lift generated as the helicopter transitions from a hover to horizontal flight. Translational lift is due to the increased efficiency of the rotor system as it generates more lift in forward flight with a higher inflow velocity of air mass comparison with a hover.

**Ultra High Frequency (UHF)-** The spectrum of radio frequencies in the 300 MHz to 3 GHz (3,000 MHz).

**Useful Load-**The difference between the gross weight and the basic empty weight is referred to as useful load. It includes the flight crew, usable fuel, drainable oil, if applicable, and payload.

**Vertical Reference-** A technique used by the helicopter pilot and flight crew, while operating above the ground, to determine the height of the aircraft and any associated external load through visual clues. Surface landmarks and references are used during approaches, departures, and external-load positioning maneuvers at landing or work areas.

**Very High Frequency (VHF)-** The spectrum of radio frequencies in the 30 MHz to 300 MHz range. This contains aeronautical frequencies and land mobile radio spectrum.

**VHF Omnidirectional Radio Range (VOR)-** An aircraft navigation system operating in the VHF band. VORs broadcast a VHF radio composite signal including the station's Morse Code identifier (and sometimes a voice identifier), and data that allows the airborne receiving equipment to derive the magnetic bearing from the station to the aircraft. This line of position is called the "radial".

**Vis-** slang: visibility.

**Visual Flight Rules (VFR)**- The rules for conducting flight operations under visual meteorological conditions (VMC). Depending upon the class of airspace, aircraft flying under VFR are not required to be in contact with air traffic controllers and are responsible for their own separation from other aircraft. The term also is used in the United States to indicate weather conditions that meet or exceed minimum VFR requirements.

**Visual Meteorological Conditions (VMC)**- The meteorological conditions expressed in terms of visibility, distance from cloud, and ceiling equal to or better than specified minima. U.S. Class C and D airspace: 3 statute miles visibility, 2000 ft. horizontally from clouds, 1000 ft. above and 500 ft. below clouds.

**Weight and Balance**- Airframe calculations based upon the amount of cyclic control power available, which establish both the longitudinal and lateral CG envelopes of a helicopter so that it is loaded in a manner so there is sufficient cyclic control for all flight conditions.

## APPENDICES

### Appendix A- Checklist For Precision In Emergency Response Safety

This job aid has been developed to promote effective decision making and risk management during emergency operations. It highlights numerous operational red flags. Use of this tool should not delay your decision making; rather it should be consulted as a reference on a recurring basis. Review these principles in advance.

*5M Model of Systematic Risk Management: mission, method, management, man, and medium.*

#### **MISSION** (Incident Assignment)

- Have you obtained all available initial mission information?
- Are your mission image and plan accurate?
- What is the operational tempo?
  - Be vigilant for “go fever” in personnel.
  - Watch out for personnel running or shouting.
  - Don’t allow the level of urgency to drive the mission.
- Is a response appropriate at this time?
  - Calculate the accurate urgency of the situation.

#### **METHOD** (Techniques and Means of Conducting the Mission)

- Is the level of response appropriate?
  - Overresponding is reckless and exposes management to liability.
  - Underresponding is inexcusable and exposes management to liability.
- Have you selected the appropriate technique for the task?
- Are the correct initial actions being implemented immediately?
- Have alternative techniques been adequately evaluated?
  - Consider the time, hazards, personnel exposure, and overall efficiency involved for alternatives.
- Are operations within equipment performance capabilities?
- Are adequate systems of communication in place?
  - Actively prevent the loss of incident communications.
  - Use relays, cellular, satellite phone, or an adjacent agency frequency.
  - Use brevity, radio etiquette, clear text, and dedicated frequencies.
- Has a thorough briefing of the mission been provided for all involved personnel?
  - In-person briefings are the most effective.
  - Give clear instructions and make sure there is no misunderstanding.
- Can you identify any omissions or deficiencies in the plan?
- Are you staying ahead of the “power curve”?
  - Anticipate and take action to prevent possible delays in the mission.
  - Ensure sufficient timeliness of logistical support.
- Are any apparent shortcuts being taken by involved personnel?
- Is there disagreement over the correct technique to be used?

- Solidly review the conservative method/approach/technique.
- Are the dynamics of the mission being observed?
  - Reevaluate and update your mission image.
- Are you making false assumptions?
  - Gather and consider all the field intelligence you can.
- Have you considered outside resources?
- Have you accounted for failure of the plan?
  - Have a backup plan available and be prepared to initiate it.

**MANAGEMENT** (Controls, Procedures, Oversight, and Supervision)

- Has “command” been identified to all involved personnel?
- Is an adequate incident command system (ICS) organization in place?
- Is compliance with policy and operating procedures being shown?
- Is safety being openly promoted?
- Are established policies and procedures known by involved personnel?
- Are adequate oversight and supervision in place?
- Has staging of additional resources been identified, and is it in use?
- Is a personnel accountability system in place?
- Have plans been made for rest and rehabilitation of involved personnel?
  - Fatigue, stress, and dehydration profoundly affect performance.
  - Rotate rested personnel.
  - Provide for critical incident stress management (CISM) support.
- Is a hot debrief and/or mission review planned?
  - Actively seek out and implement mission feedback.

**MAN** (Generic Reference to Incident Personnel)

- Are personnel being overtasked?
  - Increase the number of personnel and delegate tasks.
  - Encourage personnel to request assistance.
- Is an adequate number of trained personnel being deployed?
  - Make sure rescuers’ qualifications are current.
  - Select personnel on the basis of skills and proficiency.
- Has the personal preparedness of all personnel been assessed?
  - Mental preparedness
  - Physical preparedness
  - Personal survival equipment (is the person prepared to remain overnight?)
  - Personal protective equipment (PPE)
- Is situational awareness being maintained?
- Constantly revise the mental image of the mission and incident conditions.

**MEDIUM** (Environmental Forces)

- Have all environmental hazards been openly identified?
- Are mitigation efforts being used where possible?
- Has an accurate weather forecast been obtained?
- Is the mission operating within safe environmental parameters for personnel and machines?

## Appendix B- Communications

<b>Ground-to-Air Signals</b>	
<b>V</b>	- Require Assistance
<b>X</b>	- Unable To Proceed. Require Medical Assistance
<b>N</b>	- No or negative
<b>Y</b>	- Yes or affirmative
<b>↑</b>	- Proceed In This Direction
<b>LL</b>	- All Well

### International Civil Aviation Organization (ICAO) Phonetic Alphabet

A- Alpha	M- Mike	Y- Yankee
B- Bravo	N- November	Z- Zulu
C- Charlie	O- Oscar	1- Wun
D- Delta	P- Papa	2- Too
E- Echo	Q- Quebec	3- Tree
F- Foxtrot	R- Romeo	4- Fow-er
G- Golf	S- Sierra	5- Fife
H- Hotel	T- Tango	6- Six
I- India	U- Uniform	7- Seven
J- Juliet	V- Victor	8- Ait
K- Kilo	W- Whiskey	9- Nin-er
L- Lima	X- X-Ray	0- Ze-ro

## SEARCH AND RESCUE FREQUENCIES

The following frequencies are the internationally recognized SAR frequencies.

### Distress/Emergency Frequencies

**406.0 MHz- International voice aeronautical and shipboard emergency (UHF).\***

243.0 MHz- Joint/combined military aeronautical emergency (UHF).

123.1 MHz- NATO/ICAO Scene of Action (SAR)

**121.5 MHz- International aeronautical emergency distress frequency (VHF)**

156.8 MHz- International Maritime Distress (Channel 16)- FM voice distress (VHF)

40.50 MHz- VHF-FM Emergency (U.S. Army FM distress)

8364 kHz- International SAR lifeboat, life raft, and survival craft

2182 kHz- Maritime Mobile Distress

2670 kHz- USCG Emergency Coordination

500 kHz- International Distress

\*Emergency ELT, EPIRB, and Personal Location beacon (PLB) distress frequency

### Commonly Used On-Scene SAR Frequencies

2670 kHz- Coast Guard HF working frequency

3024.4 kHz- International voice SAR on scene (3023)

5680 kHz- International voice SAR on scene

**123.1 MHz- International voice SAR on-scene PRIMARY.**

138.78 MHz- U.S. military voice SAR on scene and direction finder (DF)

**155.16 MHz- FM frequency used by some states for coordinating SAR operations**

157.1 MHz- Coast Guard VHF-FM working frequency (CH 22A)

282.8 MHz- Joint/combined on scene and DF (UHF)

243.0 MHz- Motor whaleboat/rescue helicopter communications

381.8 MHz- Coast Guard Command net (working frequency between USCG aircraft, cutters, etc.).

Source: Navy SAR Manual 3-50.1. April 2009 edition.

## Appendix C- Helicopter Hoist Rescue Checklists

### U.S. AIR FORCE

#### HH-60 HOIST OPERATOR PRE-MISSION CHECKLIST



1. **Gunners Belt** – On -Inform pilot when duties require being out of seat with cabin doors/windows open (gunner's belt worn).
2. **Intercom System** – Set.
3. **Gloves** – On
4. **Door** – Open. (ensure all equipment is secure prior)
5. **Rescue Hoist Power Switch** – On.
6. **Ensure Backup Pump On Advisory Light Is On.**
7. **Shear Arm Switch (CCB)** – Press (Armed Light On).
8. **Rescue Device** – As Required.
9. **Lock Pin** – As Required.
10. **Searchlight** – As Required.



## U.S. PARK POLICE- HOIST RESCUE CHECK LIST



### PART ONE

1. **Secure Cabin** - Ensure interior of cabin is secure and ready for hoist operation. All gear should be tied down and equipment configured to allow hoisting of rescue device.
2. **Nightsun Control Box** - Position next to cabin door for easy access during hoist operations.
3. **Safety Harness** - Ensure safety harness is secured to hard point. Adjust belt to fit comfortably - adjust length of tether. Ensure proper donning of PFD to include leg straps (if applicable).
4. **Helmet Visor** - Visors should be down whenever cabin door is open. (For night operations, if a clear helmet visor is not available, use safety glasses).
5. **ICS Cord** - Ensure ICS cord is available. Additionally, the other right side ICS box should be strapped to the overhead and available for use in the event of failure.
6. **Rescue Device/Swimmer** - The device or swimmer should be ready to be attached to the hoist or for free fall deployment.
7. **Cable Cutters** - Cutters should be in close proximity and secured with a lanyard to prevent dropping from aircraft if employed.
8. **Hoist Gloves** - Donned prior to arrival

At the completion, crewmember announces "**Rescue Checklist Part One complete**".

### PART TWO

Rescue Checklist Part Two should be completed immediately preceding an actual hoist. These are the final steps taken in order to perform a hoist.

1. **Request Hoist Power/Enable Cable Cutter** - Pilot will turn hoist on and reset cable cutter circuit breaker.
2. Rig the **rescue device or rescuer** to the hoist
3. **Audio Check** - Check hot mike and all receiver volumes and settings to avoid interference during hoist.
4. Report - "**Rescue Checklist Part Two complete- one rigged and ready aft.**"  
Following this last advisory, the Pilot will begin his/her approach to the target.

## CALIFORNIA HIGHWAY PATROL



### RESCUE HOIST OPERATIONS CHECKLIST

1. **Crewmembers qualified and current.**
2. **OAQ (owned and operated) authorized equipment only.**
3. **Supervisor should be notified, if possible.**
4. **No night operations.**
5. **HOGA power available and computed.**
6. **Weight and balance within limits:**
  - Longitudinal.
  - Lateral.
  - Gross weight.
7. **Rescue hoist properly installed, pre-flighted and operationally checked:**
  - Check for general condition, proper safeties and serviceability.
  - Check operation of unit.
  - Preflight cable cutter device.
  - Check cargo mirror installation and adjustment, if applicable.
8. **Preflight mission equipment/rigging. Double check flight officer's safety harness and its attachment points/connections.**
9. **Crew/mission briefing completed:**
  - Mission procedures.
  - Communications procedures:
    - ❖ Radio.
      - Frequencies.
      - Call signs.
      - Lost communications procedures.
      - Terminology, etc.
    - ❖ Hand signals.
10. **Emergency procedures briefed:**
  - Cable cut procedures.
    - ❖ Cut non-live loads.
    - ❖ Flight officer lowers live load to the ground.
  - Static electricity brief:
    - ❖ Key CHP radio.

- ❖ Ground line/cable prior to touching.
- Entangled cable: Caution tension!
- Pendulum action:
  - ❖ Move cable opposite of swing.
  - ❖ If rotating, rotate cable opposite of rotation.

**11. Staging area selection/preparation:**

- Size.
- Approach/departure paths.
- Wind.
- Weather.
- Dust/snow/debris.
- Density altitude.
- Visibility (low sun).
- obstructions/terrain/hazards/barriers/wires.
- No unnecessary personnel in the area.

**12. Non-live loads: cable cutter device armed.**

**13. Live loads.**

- Circuit breaker pulled/disarmed. (not fuses).
- If outside, keep victim(s) at a low altitude

## TRAVIS COUNTY STARFLIGHT- CREW CHIEF HOIST CHECKLIST



### **Crew Chief**

The Crew Chief will ensure that the aircraft is properly configured for SAR missions to include confirming the rappel bar is securely attached to the aircraft, and that the “**load release handle**” is locked and safety pinned in position

Crew Chief will perform a safety inspection of all crewmembers ensuring proper PPE for the mission

Crew Chief will begin radio communication with ground units

Crew Chief will complete pre-rescue safety inspection of the Helicopter Rescue Specialist (HRS)

### **CABIN SECURED**

Prior to calling cabin secure the Crew Chief will ensure that the HRS and all equipment are properly secured

### **DOOR OPEN AND LOCKED**

The Crew Chief will move into position for rescue operations at the front of the right sliding door

### **REQUEST HOIST POWER**

### **LIGHT CHECK OK**

Crew Chief will deploy hoist cable to the HRS

### **CREW CHIEF RADIO TEST**

### **RESCUER READY**

Crew Chief will boom HRS into ready position but will not lower HRS until Pilot gives the command

### **RESCUER IN POSITION**

### **HOIST RUNNING**

Crew Chief will provide Pilot with progress of HRS on hoist (e.g. HRS at 15 feet, 30 feet etc.)

### **CONFIRMING AIRSPEED/ ALTITUDE**

Crew Chief will confirm proper position, altitude, speed

**CHECKED**

Crew Chief will then begin to give Pilot corrective commands to the target LZ

**DECISION CHECKED**

Crew Chief will make final movement commands as the HRS nears the ground

**FORWARD 10, 5, 4, 3, 2, 1..STOP FORWARD, HOLD POSITION**

**RESCUER ON GROUND**

**RESCUER DISCONNECTING**

**HOOK FREE**

**HOIST RUNNING**

**AXIS CLEAR**

Crew Chief will provide commentary on progress of the hoist hook as it is retrieved and call clear when the hook can be retrieved without striking any obstacles

**DECISION CHECKED**

**HOOK STOWED- BOOM IN**

**REQUEST HOIST POWER OFF**

**PENDANT IS OFF AND STOWED**

**DOOR CLOSED/ CABIN SECURE**

## SAN DIEGO FIRE-RESCUE- AIR OPERATIONS DIVISION

### Hoist Operators Checklist

1. Operations briefing completed
2. Hoist operator attached and secure
3. All passengers attached and secure
4. (PFD) Donned- N/A
5. All equipment attached and secure
6. No loose items in the cabin
7. Ensure necessary power
8. Ensure escape route identified
9. Radio communication plan identified
10. Both doors open and secure
11. Power to the hoist
12. I have a green light
13. Right side clear, tail is clear
14. Clear to lift



## Appendix D- Airspace

### AIRSPACE CLASSES

The National Airspace System (NAS) is divided into several standardized types, ranging from A through G — with A being the most restrictive and G the least restrictive.

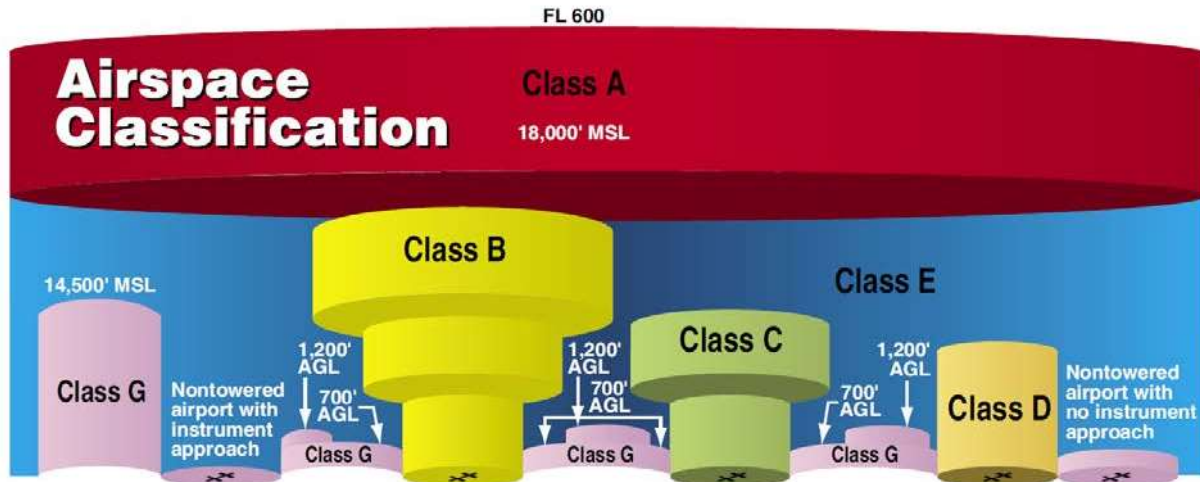

Figure 64- Airspace profile. Image courtesy FAA.

- **Class A:** High altitude controlled airspace at 18,000-60,000 feet. All aircraft are subject to ATC clearance. All flights are separated from each other by air traffic control (ATC).
- **Class B:** Surface to typically 10,000 feet around major airports to control traffic flow. All aircraft are subject to ATC clearance.
- **Class C:** Used around airports with a moderate traffic flow. All aircraft are required to have two-way radio communications with the ATC facility serving the airport.
- **Class D:** Used around smaller airports with a tower. All flights have radio contact with ATC.
- **Class E:** Operations may be conducted under IFR, SVFR, or VFR. Aircraft operating under IFR and SVFR are separated from each other, and are subject to ATC clearance. Flights under VFR are not subject to ATC clearance. As far as is practical, traffic information is given to all flights in respect of VFR flights.
- **Class G:** Uncontrolled airspace found near the ground and outside of controlled airspace regions typically in remote areas. Operations may be conducted under IFR or VFR. ATC separation is not provided.

### SPECIAL USE AIRSPACE

Special Use Airspace (SUA) designation was initiated in the early 1970's after a series of collisions and near-collisions between military and general aviation. The details of a particular SUA are listed on the applicable aeronautical sectional chart. There are six different kinds of SUA in the United States;

1. PA—Prohibited Areas
2. RA— Restricted Areas
3. MOA—Military Operations Areas
4. AA —Alert Areas
5. WA —Warning Areas
6. CFA —Controlled Firing Areas

### **Prohibited Areas**

A great description of a Prohibited Area (PA) is “unless you have the President flying in the right seat with you, don’t attempt to fly through a prohibited area”. According to the Airman’s Information Manual they are established for “security or other reasons associated with the national welfare”. PAs keep aircraft from flying over the White House and other parts of Washington, DC, ex-president’s homes. One interesting PA is the Boundary Waters Canoe Area in Minnesota. PAs are published in the Federal Register and are depicted on aeronautical charts.

### **Restricted Areas**

A Restricted Area (RA) is designated when it is necessary to confine or segregate activities considered hazardous to non-participating aircraft. They may contain hazards to flying such as artillery firing, aerial gunnery, or guided missiles. You do not want to fly in restricted areas without permission from the using or controlling agency. Such flying could be hazardous to you and your aircraft’s health and well-being. If you find yourself requested to fly within restricted areas, make sure you have permission and clearance prior to entry. RAs are depicted on the En Route Chart and aeronautical charts.

### **Military Operations Areas**

Military Operations Areas (MOA) were established to contain certain military activities such as air combat maneuvers, intercepts, acrobatics, etc. There are many MOAs over resource areas in the United States. It will not be uncommon to find yourself flying within one. Civilian flights within MOA are not prohibited (even when the area is “HOT” but you may encounter high-speed flight training, acrobatic or abrupt flight maneuvers (under 250 KIA’s). Altitudes for MOA’s will vary, but they run from ground surface to 18,000 feet. The status of MOA’s can change frequently. You should contact the Flight Service Station (FSS) within 100 miles of the area to obtain information concerning the MOAs hours of operation. FSS will only provide information on MOAs WHEN SPECIFICALLY REQUESTED. Exercise extreme caution when flying within a MOA. Also, have your lights on for better visibility. MOAs are depicted on Sectional, VFR Terminal, Area and Low Altitude En Route Charts.

### **Alert Areas**

An Alert Areas (AA) may contain a high volume of pilot training or an unusual type of aerial activity. A high volume of activity is considered as 250,000 operations a year (such as the Gulf Coast off shore operations). It is an airspace where you should be particularly “alert” when flying. All activities are conducted in accordance with FAR’s. It might be an area for military activity, aircraft manufacturers or a high concentration of aviation activity, i.e. helicopters operating near oil rigs. AAs are depicted on aeronautical charts.



### **Warning Areas**

A Warning Area (WA) could contain the same kind of hazardous flight activity as a RA, however, they are located over international waters. This means artillery firing, aerial gunnery, or guided missiles. The reason it is called a WA (instead of a RA) is because it is located over International waters. Until recently, International waters started at three miles from the U.S. coastline. However, the FAA recently extended airspace authority to 12 miles and made ALL AIRSPACE between three and 12 miles a WA. You can fly VFR through a WA and chance it. If you choose to fly IFR, ATC will not permit it unless separation is guaranteed. WAs are depicted on aeronautical charts.

### **Controlled Firing Areas**

The most unusual aspect of CFAs are they are not charted anywhere! It is not on your sectional. It is an airspace that contains activities (such as artillery firing) that, if not contained, could be hazardous to “non-participating” aircraft. The distinguishing feature of a CFA is that it utilizes a spotter or ground lookout positions that indicate when an aircraft might be approaching the area. All activities are then suspended. The FAA does not chart the CFA's because they don't require a non-participating aircraft to change it's flight path. CFAs must have 5 miles visibility or radar. A safety officer is in contact with an observer. Activities include EOD, artillery, small arms, static rocket tests and chemical disposals. CFAs are the only category of SUA that is uncharted.

## Appendix E- Military Rescue Helicopters

**Note:** This list provides a reference to the principal rescue helicopters operated by the Department of Defense and Department of Homeland Security. This is not a list of all operational rescue helicopters in the U.S.

### Sikorsky HH-60J (Jayhawk)

Operator: DHS- U.S. Coast Guard  
Crew: Four (pilot, co-pilot, two flight crew)  
Passenger Capacity: 6  
Length: 64 ft. 10 in (19.76 m)  
Rotor diameter: 53 ft. 8 in (16.36 m)  
Height: 17 ft. (5.18 m)  
Empty weight: 14,500 lb. (6,580 kg)  
Max. takeoff weight: 21,884 lb. (9,926 kg)



#### Performance

- Cruise speed: 140 kt (160 mph, 260 km/h)
- Range: 700 nautical miles (802 mi, 1,300 km)
- Service ceiling: 5,000 ft. hovering (1,520 m)

### Sikorsky UH-60 Black Hawk

Operator: U.S. Army and DHS-  
CBP  
Crew: 2 pilots (flight crew) with 2  
crew chiefs/gunners  
Capacity: 2,640 lb. (1,200 kg) of  
cargo internally, including 11  
troops or 6 stretchers, or 8,000 lb.  
(3,600 kg) (UH-60A) or 9,000 lb.  
(4,100 kg) (UH-60L) of cargo externally  
Length: 64 ft. 10 in (19.76 m)  
Fuselage width: 7 ft. 9 in (2.36 m)  
Rotor diameter: 53 ft. 8 in (16.36 m)  
Height: 16 ft. 10 in (5.13 m)  
Disc area: 2,260 ft<sup>2</sup> (210 m<sup>2</sup>)  
Empty weight: 10,624 lb. (4,819 kg)  
Loaded weight: 22,000 lb. (9,980 kg)  
Max. takeoff weight: 23,500 lb. (10,660 kg)

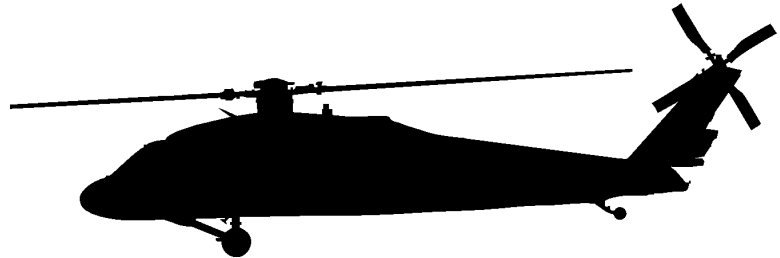

#### Performance

- Cruise speed: 150 kt (173 mph, 278 km/h)
- Combat radius: 368 mi (320 nmi, 592 km)
- Ferry range: 1,380 mi (1,200 nmi, 2,220 km) with external tanks
- Service ceiling: 19,000 ft. (5,790 m)

### **Sikorsky HH-60 Pave Hawk**

Operator: U.S. Air Force  
Crew: 4 (2 pilots, flight engineer, gunner)  
Capacity: max. crew 6, 8–12 troops, plus litters and/or other cargo  
Length: 64 ft. 10 in (17.1 m)  
Rotor diameter: 53 ft. 8 in (14.1 m)  
Height: 16 ft. 8 in (5.1 m)  
Empty weight: 16,000 lb. (7,260 kg)  
Max. takeoff weight: 22,000 lb. (9,900 kg)

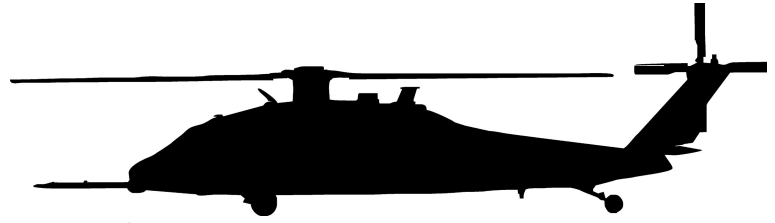

#### Performance

Maximum speed: 195 knots (224 mph, 360 km/h)  
Cruise speed: 159 kt (184 mph, 294 km/h)  
Range: 373 mi (internal fuel), or 508 mi (with external tanks) (600 km, or 818 km)  
Service ceiling: 14,000 ft. (4,267 m)

### **Sikorsky SH-60 Seahawk**

Operator: U.S. Navy  
Crew: 3–4  
Capacity: 5 passengers in cabin, slung load of 6,000 lb. (2,700 kg) or internal load of 4,100 lb. (1,900 kg) for B, F and H models; and 11 passengers or slung load of 9,000 lb. (4,100 kg) for S-model  
Length: 64 ft. 8 in (19.75 m)  
Rotor diameter: 53 ft. 8 in (16.35 m)  
Height: 17 ft. 2 in (5.2 m)  
Disc area: 2,262 ft<sup>2</sup> (210 m<sup>2</sup>)  
Empty weight: 15,200 lb. (6,895 kg)  
Loaded weight: 17,758 lb. (8,055 kg)  
Useful load: 6,684 lb. (3,031 kg)  
Max. takeoff weight: 21,884 lb. (9,927 kg)



#### Performance

- Maximum speed: 146 kt (270 km/h; 168 mph)
- Range: 450 nmi (518 mi or 834 km) at cruise speed
- Service ceiling: 12,000 ft. (3,580 m)

### **Boeing CH-47 Chinook**

Operator: U.S. Army

Crew: 3 (pilot, copilot, flight engineer)

Capacity: 33–55 troops or 24 litters and 3 attendants or 28,000 lb. (12,700 kg) cargo

Length: 98 ft. 10 in (30.1 m)

Rotor diameter: 60 ft. 0 in (18.3 m)

Height: 18 ft. 11 in (5.7 m)

Disc area: 5,600 ft<sup>2</sup> (520 m<sup>2</sup>)

Empty weight: 23,400 lb. (10,185 kg)

Loaded weight: 26,680 lb. (12,100 kg)

Max. takeoff weight: 50,000 lb. (22,680 kg)

Powerplant: 2 × Lycoming T55-GA-714A turboshaft, 4,733 hp (3,631 kW) each

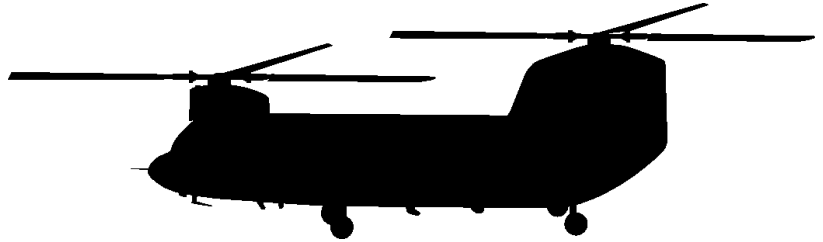

#### Performance

- Cruise speed: 130 kt (149 mph, 240 km/h)
- Range: 400 nmi (450 mi, 741 km)
- Service ceiling: 18,500 ft. (5,640 m)

### **Eurocopter UH-72 Lakota**

Operator: U.S. Army and Army National Guard

Crew: 2 pilots

Capacity: 8 troops or 2 stretchers and medical crew

Length: 42 ft. 7 in (13.03 m)

Rotor diameter: 36 ft. 1 in (11.00 m)

Height: 11 ft. 9 in (3.45 m)

Disc area: 1,023 ft<sup>2</sup> (94.98 m<sup>2</sup>)

Empty weight: 3,950 lb. (1,792 kg)

Useful load: 3,953 lb. (1,793 kg)

Max. takeoff weight: 7,903 lb. (3,585 kg)



#### Performance

- Cruise speed: 133 knots (153 mph, 246 km/h)
- Range: 370 nmi (426 mi, 685 km)
- Service ceiling: 18,000 ft. (5,791 m)

## **Eurocopter HH-65 Dauphin**

Operator: DHS- U.S. Coast Guard

Crew: 2 pilots and 2 crew

Length: 11.6 m (38 ft. 1 in)

Height: 4 m (13 ft. 1 in)

Empty weight: 3,128 kg (6,896 lb.)

Max takeoff weight: 4,300 kg (9,480 lb.)

Powerplant: 2 × Turbomeca Arriel 2C2-CG turboshaft engines, 636 kW (853 hp) each

Main rotor diameter: 11.9 m (39 ft. 1 in)

Main rotor area: 38.54 m<sup>2</sup> (414.8 sq. ft.)



### Performance

- Maximum speed: 324 km/h; 201 mph (175 kt.)
- Range: 658 km (409 mi; 355 nmi)
- Service ceiling: 5,486 m (17,999 ft.)

## Appendix F- U.S. Air Force Helicopter Landing Zone (HLZ) Requirements

Source: AIR FORCE INSTRUCTION 13-217 (10-27-2007)- DROP ZONE AND LANDING ZONE OPERATIONS



A minimum of two rotor diameters is required for single-ship training. Use the following square dimensions to determine single-ship HLZs: MH-53 = 150 ft. (72 ft. rotor diameter); UH-1 = 100 ft. (48 ft. rotor diameter); CV-22=170 ft. (85 ft. rotor diameter); HH-60 = 110 ft. (54 ft. rotor diameter).

For multi-ship operations, multiply single-ship dimensions by the number of aircraft to determine HLZ capacity (e.g., a 4-ship of MH-53s would require a 600 ft. x 150 ft. long HLZ).

For contingency operations use the following dimensions to determine single-ship HLZs: MH-53 use 125 ft. W x 140 ft. L; CV-22 use 135 ft. W x 110 ft. L; HH-60 use 105 ft. W x 115 ft. L. UH-1 use 25-ft. clearance from any portion of the helicopter to the nearest obstacle. For multi-ship operations, multiply the number of aircraft by 150 ft. W x 150 ft. L (e.g., a 4-ship of MH-53's would require a 600 ft. W x 150 ft. L HLZ).

HH-60 slope limits: 6 degrees nose-down, 15 degrees nose-up, 15 degrees left/ right. Aircrew will subtract 2 degrees from each limit for each 5 knots of wind

### HH-60 Helicopter Landing Zone Size

- Operational Weight (Empty) - 14,600 lbs.
- Max. Gross Weight - 24,500 lbs.
- Rotor Size - 54 ft.'
- Length - 65 ft.
- Footprint Width - 8 ft.
- Footprint Length – 40 ft.
- Minimum HLZ Size Training - 25 ft. clearance from any portion of the helicopter to the nearest obstacle.
- Contingency - 25 ft. clearance from any portion of the helicopter to the nearest obstacle.

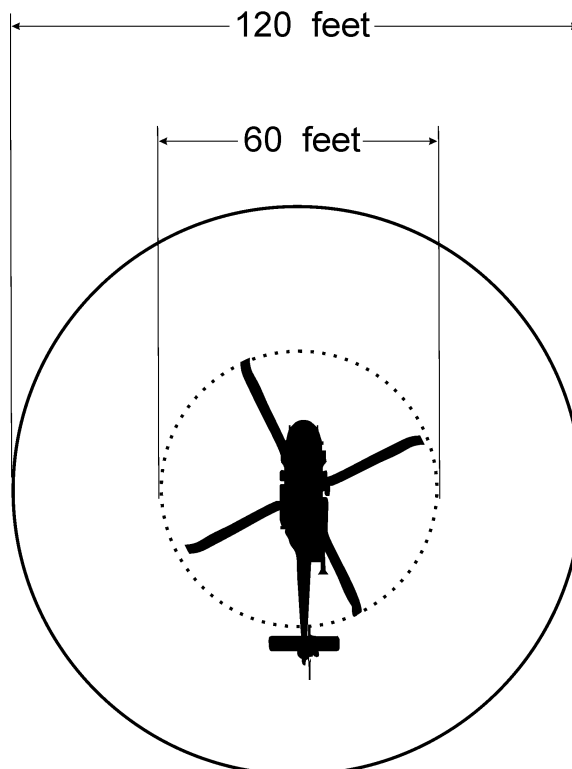

**MH-47E Helicopter Landing Zone Size**

- Operational Weight (Empty) - 32,000 lbs.
- Max. Gross Weight - 50,000 lbs.
- Rotor Size – 60 ft.
- Length - 99 ft.
- Footprint Width - 9 ft.
- Footprint Length – 30 ft.
- Minimum HLZ Size Training – 120 ft. X 120 ft.
- Contingency – 110 ft. W X 140 ft. L

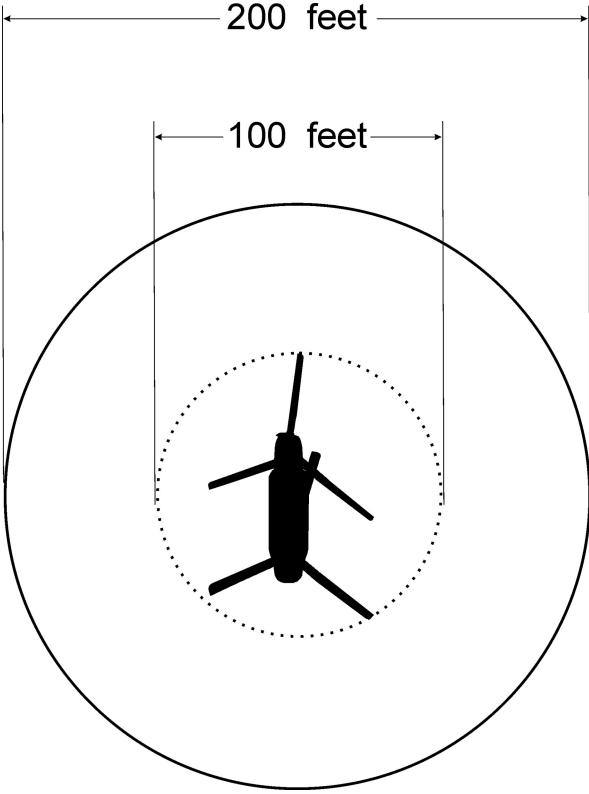

Illustrations by Ken Phillips

## Appendix G- JFIRE Manual- Helicopter Landing Zone (HLZ) Brief



Source: Army, Marine Corps, Navy, and Air Force JFIRE (Multi-Service Tactics, Techniques, and Procedures for the Joint Application of Firepower). Appendix H. November 2012

### Zone Location

- Geographical feature, checkpoint, grid, road intersection, etc.

### Marked by

- Air panel, buzzsaw (spinning chemlight on cord), chemical lights, infrared strobes, smoke, talk-on, etc.

### Obstacles

- Power lines, trees, etc.
- Include height of obstacle

### Winds are from \_\_\_\_\_

- Tell aircraft from which sub-cardinal heading winds are blowing.
- Include the estimated speed in knots or estimated strength, such as strong or light.

Note: Aircraft should always land into the wind.