



ReVel™ ventilator quick transport guide

Critical care ventilation



CareFusion



Table of contents

Turn ReVel™ ventilator on.....	1
Check battery level of ReVel ventilator.....	2–3
Check battery level of additional battery packs	4
Decide if you want to include alternative power source	5
Connect ReVel ventilator to power source	6
Choose circuit.....	7
Connect circuit	8
Oxygen use	9
New patient setting.....	10
Set for patient size.....	11
Connect circuit to ET-tube or mask.....	12
Intubate or NPPV	13
Optional: Considerations for NPPV	14–15

The ReVel ventilator transport guide is intended to be used as an educational supplement, not as a replacement for the operator manual. You must become completely familiar with the ReVel ventilator operator manual before using the ventilator.

For 24-hour assistance,
call **800.754.1914**.

Step 1. Turn ReVel ventilator on

Push the On/Off button on the lower interface panel. Verify that the ventilator powers up, displays the ventilator model name (*ReVel*) or part number (*XXXXX-XXX*) followed by *Same Patient* in the display window.

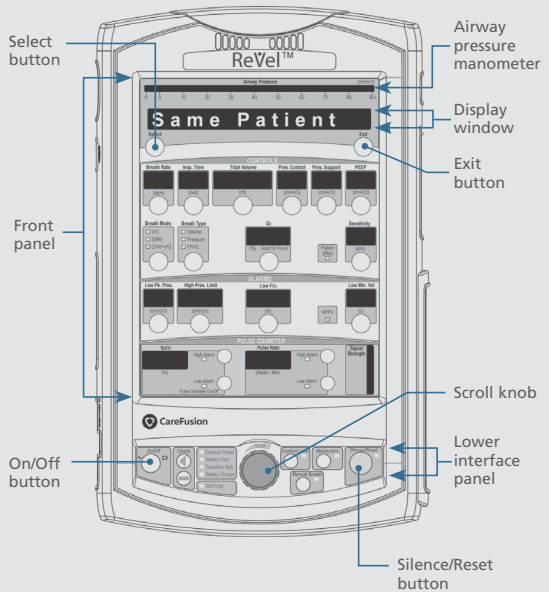

For 24-hour assistance,
call **800.754.1914**.

Step 2. Check battery level of ReVel ventilator

Push and hold down the Battery/Power Check button on the lower interface panel of the ventilator.

View the display window for updates on the battery pack and transitional battery.

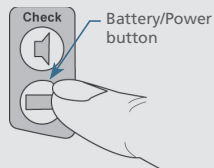

Possible status messages displayed

Removable battery pack	External DC power	Docking station	Transition battery
Batt xxx%	Ext OK	Dock OK	T-Bat OK
Batt Removed	Ext Low	Dock Low	T-Bat Low
Batt Fault	Ext Removed	Dock Removed	T-Bat Remove
	Ext Fault	Dock Fault	T-Bat Charge
			T-Bat Fault

Continued

For 24-hour assistance,
call **800.754.1914**.

Step 2. Check battery level of ReVel ventilator (*continued*)

If any fault message (*xxxxx Fault*) displays, it is an indication that the displayed source of power (*Batt, Ext, Dock or T-Bat*) has been detected and is not adequate to power the ventilator.

Considerations for battery pack use during transport

- Assure additional fully charged battery packs are available during routes.
- Do not operate the ventilator using the transitional battery as the sole source of power for more than one minute. The transitional battery charges the ventilator while hot swapping the battery pack to ensure patient receives uninterrupted ventilation.

Step 3. Check battery level of additional battery packs

Keep the battery pack charge level as high as possible prior to use. A fully charged battery should operate the ventilator for a maximum of four hours.

To check the battery charge, push and hold the Test button as shown.

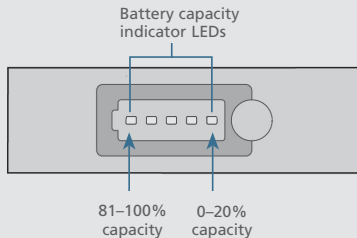
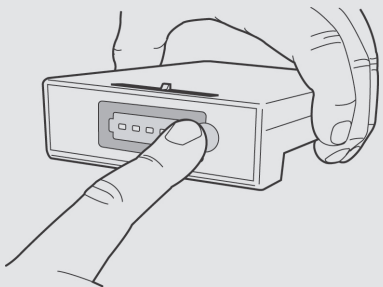

Step 4. Decide if you want to include alternative power source

Optional: Use the AC adapter when AC power is available.

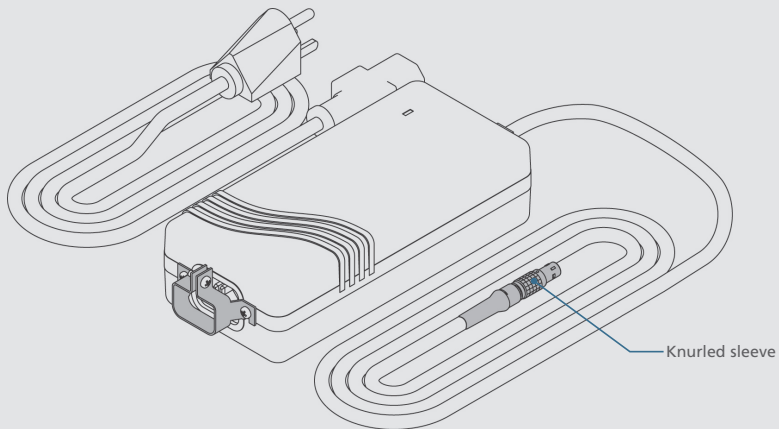

For 24-hour assistance,
call **800.754.1914**.

Step 5. Connect ReVel ventilator to power source

Insert a new four-hour hot-swappable battery pack when required.

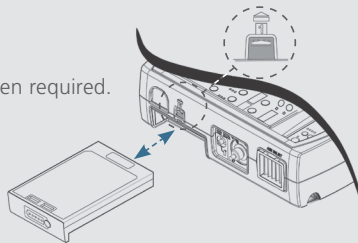

Use the AC adapter when AC power is available.

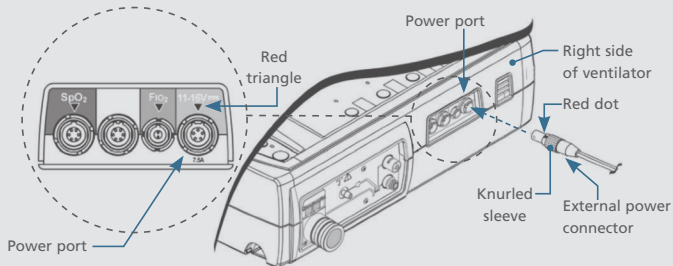

For 24-hour assistance,
call **800.754.1914**.

Step 6. Choose circuit



Open the bag, and remove the patient circuit.

Includes two optional circuits for:

Humidifier

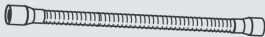

Oxygen analyzer

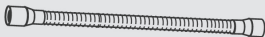

For 24-hour assistance,
call **800.754.1914**.

Adult 22 mm patient circuit

>20 kg (>44 lb)

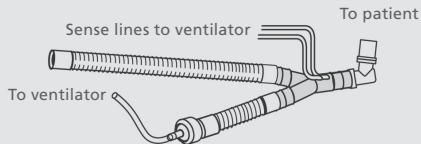

Infant/pediatric 15 mm patient circuit

5–20 kg (11–44 lb)

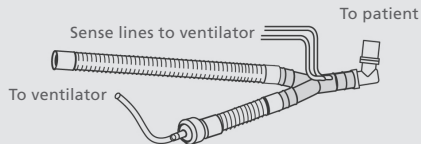

Step 7. Connect circuit

- 1 Connect the inspiratory limb of the patient breathing circuit to the inspiratory port on the right side of the ventilator.
- 2 Connect the exhalation valve drive line of the patient breathing circuit to the exhalation valve drive line port (hose barb) on the right side of the ventilator.
- 3 Connect the patient circuit wye sense lines (two, each with non-interchangeable luer fittings) to the sense line ports on the right side of the ventilator.

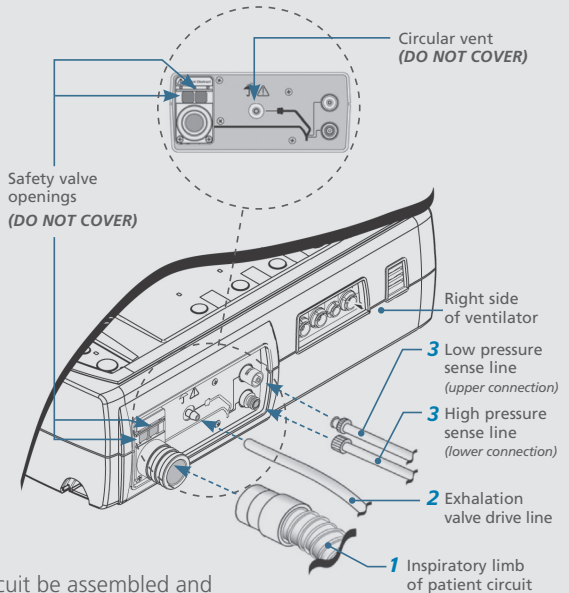

Consider performing a circuit test.

It is suggested that the ventilator circuit be assembled and tested prior to patient transport to minimize time constraints.

For 24-hour assistance,
call **800.754.1914**.

Step 8. Oxygen use

- Using low pressure with a flowmeter:
 - Select the appropriate chart based on the Bias Flow setting. When Leak Compensation is ON, the patient leak should be added to the Bias Flow.
 - Identify the desired FiO_2 . (**A, B and C**)
 - Identify the patient's minute ventilation (Ve) using the formula $Ve = Vt \times \text{breath rate}$.
- Locate the Minute Volume reading. Viewing the right side of the chart:
 - Follow the vertical FiO_2 line up to the applicable Ve line.
 - Where they intersect, read across horizontally to the left side of the chart to the required O_2 flow (L/min).

Note: While the ventilator is moved, patient sensitivity may need to be adjusted. When auto cycling is present, reduce the sensitivity by increasing the Flow Trigger. If auto cycling cannot be relieved by adjusting the Flow Trigger, consider using the Pressure Trigger.

For 24-hour assistance,
call **800.754.1914**.

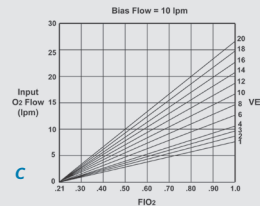
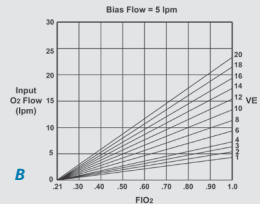
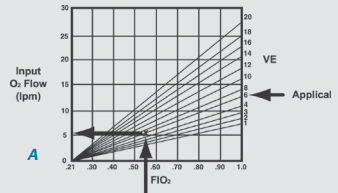

Step 9. New patient setting

When the ventilator is turned on, the window displays Same Patient.



Turn the scroll knob to the right until New Patient displays on the window.



Push the Select button to confirm.

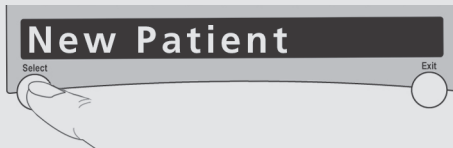

For 24-hour assistance,
call **800.754.1914**.

Step 10. Set for patient size

The window displays Patient ID.



Scroll the knob to the right until Patient Size displays on the window.



Push the Select button to confirm.

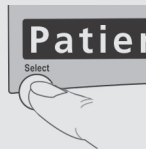

Scroll the knob until the desired patient size displays (*Infant, Pediatric or Adult*).



Push the Select button to confirm.

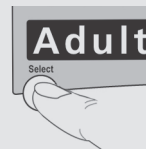

Mistake: If you make a mistake, push the Exit button to go back one step.

For 24-hour assistance,
call **800.754.1914**.

Step 11. Connect circuit to ET-tube or mask

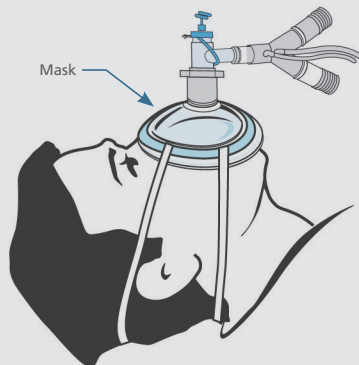
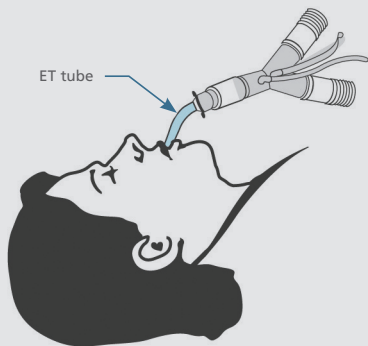

For 24-hour assistance,
call **800.754.1914**.

Step 12. Intubate or Noninvasive positive-pressure ventilation (NPPV)

Scroll the knob until the desired option displays.

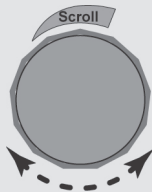

Push the Select button to confirm.

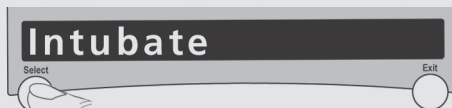

For 24-hour assistance,
call **800.754.1914**.

Step 13. Optional: Considerations for NPPV

- 1 Choose a mask
(*pediatric or adult*).



Pediatric



Adult

- 2 Connect the elbow
to the mask.

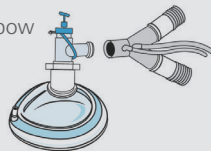

- 3 Connect the assembly
to the patient.

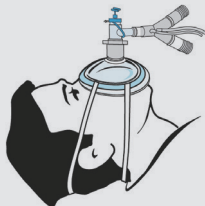

- 4 Scroll the knob until
Ventilate displays.



- 5 Push the Select
button to confirm.



Continued

For 24-hour assistance,
call **800.754.1914**.

Step 13. Optional: Considerations for NPPV (continued)

NPPV default settings

See the operator manual for changing default settings.

New patient	Preset
Adult	IPAP 16 cmH ₂ O EPAP 6 cmH ₂ O Rate 12 BPM
Pediatric	IPAP 11 cmH ₂ O EPAP 6 cmH ₂ O Rate 15 BPM
Infant	IPAP 8 cmH ₂ O EPAP 3 cmH ₂ O Rate 20 BPM

This emergency set-up card is intended to provide quick instructions for the initial set-up of the ReVel ventilator. The initial settings may need to be adjusted based on the patient's clinical condition. For complete information regarding ventilator set-up and operation, refer to the ReVel ventilator operator manual.

For 24-hour assistance,
call **800.754.1914**.



For 24-hour assistance,
call **800.754.1914**.

Caution: Federal Law restricts this
device to sale by or on the order
of a physician.

CareFusion
22745 Savi Ranch Parkway
Yorba Linda, CA 92887

800.231.2466 toll-free
714.283.2228 tel
714.283.8493 fax



carefusion.com

© 2012 CareFusion Corporation or one of its subsidiaries. All rights reserved. ReVel, CareFusion and the CareFusion logo are trademarks or registered trademarks of CareFusion Corporation or one of its subsidiaries. RC3721 (0812/2000) L3494 Rev. A



CareFusion